





 PriceList

# Switching and Controlling Products

With effect from January 15<sup>th</sup>, 2026





<b>Easy TeSys</b>	
> <b>Easy</b> TeSys Power Contactors (3 Pole) .....	08
> <b>Easy</b> TeSys Power Contactors (4 Pole) .....	09
> <b>Easy</b> TeSys Contactor Accessories .....	10
> <b>Easy</b> TeSys Thermal Overload Relay .....	12
> <b>Easy</b> TeSys Circuit Breaker for Motor Protection .....	13
<b>TeSys Control</b>	
> TeSys K Control Relays .....	18
> TeSys K Power Contactors .....	18
> TeSys K Accessories .....	19
> TeSys Capacitor Duty Contactor .....	20
> TeSys Deca Control Relays .....	21
> TeSys Deca Power Contactors (3 Pole).....	21
> TeSys Deca Power Contactors (4 Pole).....	22
> TeSys Deca Advanced Contactor (3 Pole) 	29
> TeSys Deca Advanced Contactor (4 Pole) 	29
> TeSys Deca Accessories.....	31
> TeSys Giga Power Contactors.....	39
> TeSys Giga Accessories .....	40
<b>TeSys Protect</b>	
> TeSys Overload Relay .....	44
> Electronic Over Current Relay.....	46
<b>TeSys Power</b>	
> TeSys Motor Circuit Breakers .....	49
> Circuit Breakers for Motor Protection Accessories .....	53
<b>TeSys Switches</b>	
> TeSys Switches.....	56
<b>TeSys Active</b>	
> TeSys Island .....	58
> TeSys U .....	60
> iMCC Relay.....	62
> TeSys Tera 	63





# Easy TeSys

Powering Simplicity in  
Control Solutions

Easy TeSys provides you **Essential** control and protection for your applications.



[www.se.com/in](http://www.se.com/in)

**Schneider**  
Electric

# Easy TeSys

The Easy choice for simplicity and flexibility

- 3 Pole and 4 Pole Power Contactor
- Control Relays
- Thermal Overload Relay
- Circuit Breaker for Motor Protection
- Accessories

A2L certified  
upto 50A  
for HVAC  
applications



HVAC



GenSet



Pumps



Textile



Material  
Handling



Packaging



## Easy TeSys Range (Available with Type-2 Coordination)

NEW

Designed for the essential  
Two principles to build your starter solution

### 2-components solution (Thermal-magnetic circuit breaker + Contactor)

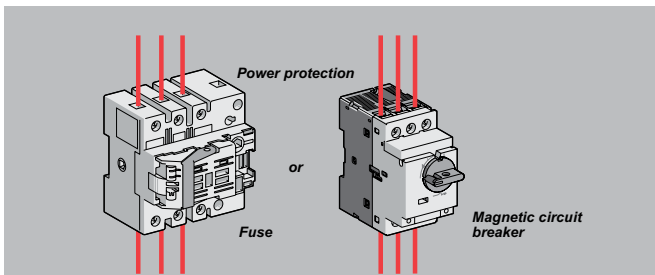

### 3-components solution (Magnetic circuit breaker or fuse + Contactor + TOR)

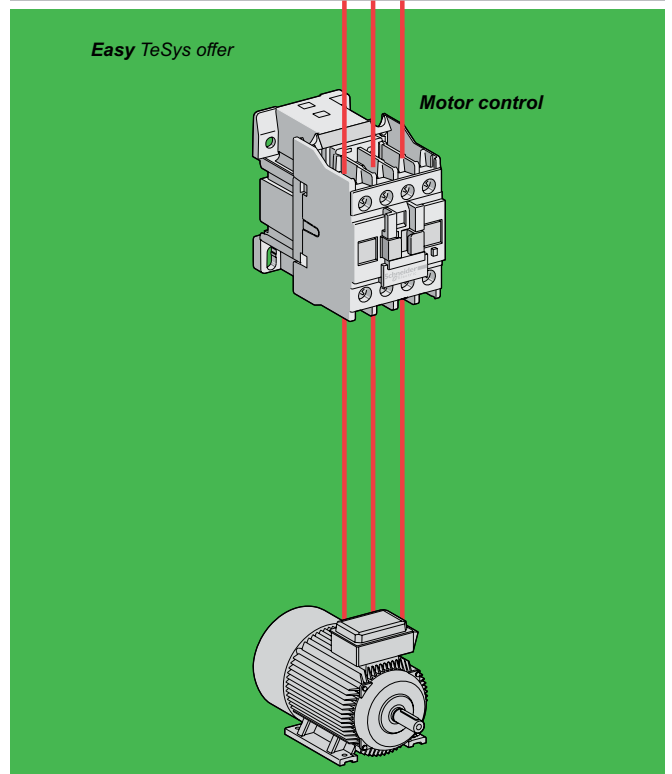
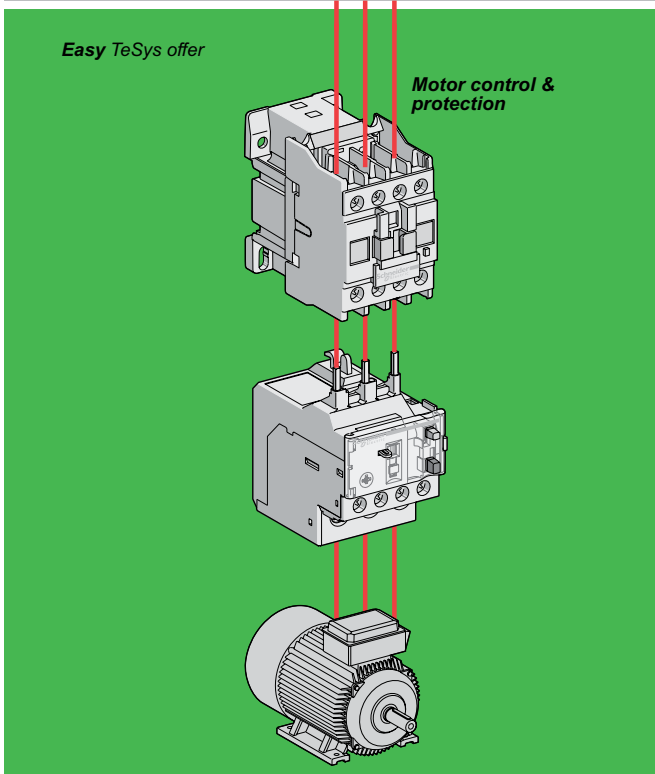
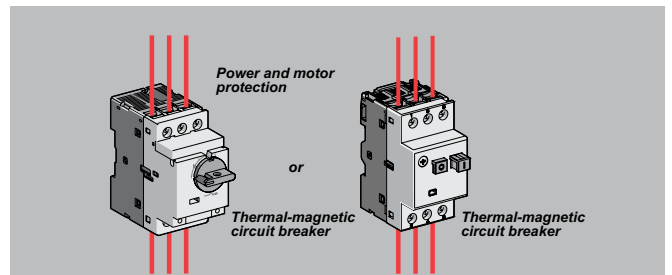

To build the essential solutions  
in an easy and simple way

## Power Contactors LC1E (3 Pole AC Control)



- Conformance to IEC 60947-4-1, CE Marking
- Current Rating: 6A to 630A, AC-3 Rating
- **Type-2 coordination available with Fuse & MPCB upto 15kW**

Frame	[Ie] Rated Operational Current		Motor Power at 415V, 3Ph, 50Hz		Auxiliary Contacts		Reference	Unit MRP [₹]	
	AC-1	AC-3	HP	kW	NO	NC		M7 (220V)	N5 (415V)
FRAME-1	20 A	6 A	3	2.2	-	1	LC1E0601* <input checked="" type="checkbox"/>	1825	2150
	20 A	6 A	3	2.2	1	-	LC1E0610* <input checked="" type="checkbox"/>	1825	-
	25 A	9 A	5.5	4	-	1	LC1E0901* <input checked="" type="checkbox"/>	1870	1870
	25 A	9 A	5.5	4	1	-	LC1E0910* <input checked="" type="checkbox"/>	1870	1870
	25 A	12 A	7.5	5.5	-	1	LC1E1201* <input checked="" type="checkbox"/>	2135	2135
	25 A	12 A	7.5	5.5	1	-	LC1E1210* <input checked="" type="checkbox"/>	2135	2135
	32 A	18 A	12	9	-	1	LC1E1801* <input checked="" type="checkbox"/>	2465	2465
	32 A	18 A	12	9	1	-	LC1E1810* <input checked="" type="checkbox"/>	2465	2465
	36 A	25 A	15	11	-	1	LC1E2501* <input checked="" type="checkbox"/>	3350	3970
	36 A	25 A	15	11	1	-	LC1E2510* <input checked="" type="checkbox"/>	3350	3350
FRAME-2	50 A	32 A	20	15	-	1	LC1E3201* <input checked="" type="checkbox"/>	7030	8315
	50 A	32 A	20	15	1	-	LC1E3210* <input checked="" type="checkbox"/>	7030	7030
	50 A	38 A	25	18.5	-	1	LC1E3801* <input checked="" type="checkbox"/>	8200	9825
	50 A	38 A	25	18.5	1	-	LC1E3810* <input checked="" type="checkbox"/>	8200	8200
	50 A	40 A	29	22	-	1	LC1E40B01* <input checked="" type="checkbox"/>	8865	-
	50 A	40 A	29	22	1	-	LC1E40B10* <input checked="" type="checkbox"/>	8865	-
FRAME-3	60 A	40 A	29	22	1	1	LC1E40* <input checked="" type="checkbox"/>	11005	11005
	70 A	50 A	34	25/30	1	1	LC1E50* <input checked="" type="checkbox"/>	13390	13390
	80 A	65 A	50	37	1	1	LC1E65* <input checked="" type="checkbox"/>	18140	18140
FRAME-4	110 A	80 A	60	45	1	1	LC1E80* <input checked="" type="checkbox"/>	23595	23595
	120 A	95 A	60	45	1	1	LC1E95* <input checked="" type="checkbox"/>	28275	28275

Frame	[Ie] Rated Operational Current		Motor Power at 415V, 3Ph, 50Hz		Auxiliary Contacts		Reference	Unit MRP [₹]			
	AC-1	AC-3	HP	kW	NO	NC		M7 (220V)	N5 (415)	M5 (220V)	N7 (415)
FRAME-5	150 A	120 A	75	55	1	1	LC1E120*	-	33685	33685	-
	200 A	160 A	120	90	1	1	LC1E160*	-	44475	44475	-
FRAME-6	250 A	200 A	150	110	-	-	LC1E200*	-	61220	61220	-
	300 A	250 A	175	132	-	-	LC1E250*	-	95350	80670	-
FRAME-7	320 A	300 A	215	160	-	-	LC1E300*	-	99320	99320	-
	500 A	400 A	295	220	-	-	LC1E400*	123945	-	-	145085
FRAME-8	700 A	500 A	375	280	-	-	LC1E500*	174585	-	-	-
FRAME-9	1000 A	630 A	500	375	-	-	LC1E630*	245585	-	-	290135

For other coil voltage ratings contactors, please contact Customer Care.

\* Reference to be completed by adding coil voltage code

## Easy TeSys 3P Power Contactors 06 – 95A, 24V DC Coil



- Power Contactors – 6A to 95A, Control Voltage- 24V DC (launched and commercialized)
- Fully tested, approved, and certified by national, international, and third-party organizations. ISO 9001 ISO 14000
- Conformance to IEC 60947-4-1, CE Marking

### Power Contactors LC1E (3 Pole DC Control)

Frame	[Ie] Rated Operational Current		Motor Power at 415V, 3Ph, 50Hz		Auxiliary Contacts		Reference	Unit MRP [₹] BD
	AC-1	AC-3	HP	kW	NO	NC		
FRAME-1	20 A	6 A	3	2.2	-	1	LC1E0601* <input checked="" type="checkbox"/>	3320
	20 A	6 A	3	2.2	1	-	LC1E0610* <input checked="" type="checkbox"/>	3320
	25 A	9 A	5.5	4	-	1	LC1E0901* <input checked="" type="checkbox"/>	3320
	25 A	9 A	5.5	4	1	-	LC1E0910* <input checked="" type="checkbox"/>	3320
	25 A	12 A	7.5	5.5	-	1	LC1E1201* <input checked="" type="checkbox"/>	3435
	25 A	12 A	7.5	5.5	1	-	LC1E1210* <input checked="" type="checkbox"/>	3435
	32 A	18 A	12	9	-	1	LC1E1801* <input checked="" type="checkbox"/>	4005
	32 A	18 A	12	9	1	-	LC1E1810* <input checked="" type="checkbox"/>	4005
	36 A	25 A	15	11	-	1	LC1E2501* <input checked="" type="checkbox"/>	5495
	36 A	25 A	15	11	1	-	LC1E2510* <input checked="" type="checkbox"/>	5495
FRAME-2	50 A	32 A	20	15	-	1	LC1E3201* <input checked="" type="checkbox"/>	12020
	50 A	32 A	20	15	1	-	LC1E3210* <input checked="" type="checkbox"/>	12020
	50 A	38 A	25	18.5	-	1	LC1E3801* <input checked="" type="checkbox"/>	13740
FRAME-3	50 A	38 A	25	18.5	1	-	LC1E3810* <input checked="" type="checkbox"/>	13740
	60 A	40 A	29	22	1	1	LC1E40** <input checked="" type="checkbox"/>	22250
	70 A	50 A	34	25/30	1	1	LC1E50**	22485
FRAME-4	80 A	65 A	50	37	1	1	LC1E65** <input checked="" type="checkbox"/>	23525
	110 A	80 A	60	45	1	1	LC1E80** <input checked="" type="checkbox"/>	30345
	120 A	95 A	60	45	1	1	LC1E95** <input checked="" type="checkbox"/>	33145

### Power Contactors - Easy TeSys (4 Pole AC Control)



- Conformance to IEC 60947-4-1, CE Marking
- Current Rating: 20A to 125A, AC-1 rating
- Available in 4NO and 2NO+2NC Power Pole combination
- Wide Band Coil for all ratings in 220 & 415V AC

Frame	AC-1 Rating	Power Poles	Reference	Unit MRP [₹]			
				B7 (24V)	F7 (110V)	M5WB (220V)	N5WB (415V)
FRAME-1	20	4NO	LC1E06004*IN	2210	2630	2210	-
	25	4NO	LC1E09004*IN	2345	2780	2345	2780
	32	4NO	LC1E12004*IN	-	-	2440	-
	40	4NO	LC1E18004*IN	3045	3045	3045	3045
FRAME-2	50	4NO	LC1E25004*IN	3855	3855	3855	3855
	55	4NO	LC1E32004*IN	-	6510	6510	-
	60	4NO	LC1E38004*IN	7615	7615	7615	7615
FRAME-3	75	4NO	LC1E40004*IN	14355	14355	11865	14355
	85	4NO	LC1E65004*IN	16050	19415	16050	16050
FRAME-4	110	4NO	LC1E80004*IN	24590	24590	20335	-
	125	4NO	LC1E95004*	-	-	22925	-

For details on non standard references, technical parameters, accessories, compatibility, stockable and non stockable status please contact Customer Care

NORMAL STOCK ITEMS

W.E.F. January 15<sup>th</sup>, 2026

Frame	AC-1 Rating	Power Poles	Reference	Unit MRP [₹]			
				B7 (24V)	F7 (110V)	M5WB (220V)	N5WB (415V)
FRAME-1	20	2NO + 2NC	LC1E06008*IN	-	-	2645	-
	25	2NO + 2NC	LC1E09008*IN	2845	2845	2845	2845
	32	2NO + 2NC	LC1E12008*IN	3625	3625	3045	-
	40	2NO + 2NC	LC1E18008*IN	3065	3065	3065	3065
FRAME-2	50	2NO + 2NC	LC1E25008*IN	-	5480	5480	6510
	55	2NO + 2NC	LC1E32008*IN	10325	-	-	10325
	60	2NO + 2NC	LC1E38008*IN	-	10760	10760	10760
FRAME-3	75	2NO + 2NC	LC1E40008*IN	15950	-	15950	19285
	85	2NO + 2NC	LC1E65008*IN	-	19935	19935	19935
FRAME-4	110	2NO + 2NC	LC1E80008*IN	-	-	28310	28310

For other coil voltage ratings contactors, please contact Customer Care.

\* Reference to be completed by adding coil voltage code

## Control Relays - CAE,

Conformance to IEC60947-5-1, CE Marking

Auxiliary Contacts		Reference	Unit MRP [₹]			
NO	NC		B5	F5	M5	N5
4	0	CAE40*	2160	1810	1810	1810
3	1	CAE31*	2160	2160	1810	2160
2	2	CAE22*	2160	1810	1810	2160

\* Reference to be completed by adding coil voltage code and recommended to check availability with Customer Care team

## Spare Coil for Contactors

Contactor	Reference
<b>4 Pole Contactors</b>	
LC1E0600*.... LC1E1800*	LAEX1T**
LC1E2500*.... LC1E3800*	LAEX2T**
LC1E4000*....LC1E9500*	LAEX4T**

### Control Contactors

CAE*	LAEX12**
------	----------

\* Reference to be completed by adding coil voltage code and recommended to check availability with Customer Care team

## Accessories - For Easy TeSys Contactors

Description	For Use with	Mounting	Contacts	Reference	Unit MRP [₹]
Auxiliary contact block	LC1E06..E630 & LC1E0600..E9500	FRONT	1NO+1NC	LAEN11 <input checked="" type="checkbox"/>	555
		FRONT	2NO	LAEN20 <input checked="" type="checkbox"/>	555
		FRONT	2NC	LAEN02 <input checked="" type="checkbox"/>	655
		FRONT	2NO+2NC	LAEN22 <input checked="" type="checkbox"/>	1010
		FRONT	4NO	LAEN40 <input checked="" type="checkbox"/>	1010
Star delta timer	LC1E25..E630			LAETSD <input checked="" type="checkbox"/>	4575

Description	For Use with	Coil Voltage	Reference	Unit MRP [₹]
Surge suppressor*	LC1E06...E95	24..48V AC	LAERCE	3020
	LC1E06...E95	110..240V AC	LAERCU	1280

\*For higher rating contactors, contact Customer Care

Description	For Use with	Reference	Unit MRP [₹]
Mechanical Interlock	LC1E06..E65 & LC1E0600*..E3800*	LAEM1	1150
	LC1E80/E95 & LC1E4000*...LC1E9500*	LAEM4	3730
	LC1E120..E160	LAEM5	6955
	LC1E200/E250	LAEM6	7095

\*Reference to be completed by adding coil voltage

For details on non standard references, technical parameters, accessories, compatibility, stockable and non stockable status please contact Customer Care

NORMAL STOCK ITEMS

W.E.F. January 15<sup>th</sup>, 2026

## 3 Pole Accessories Compatibility

Contactor	Built in contacts	LAEN**	LAERC*	LAEM
LC1E06	1NO or 1NC	1	1	1
LC1E09				
LC1E12				
LC1E18				
LC1E25				
LC1E32				
LC1E38				
LC1E40B				
LC1E40	1NO + 1NC	1	-	1
LC1E50				
LC1E65				
LC1E80				
LC1E95				
LC1E120				
LC1E160	-	2	-	-
LC1E200				
LC1E250				
LC1E300				
LC1E400				
LC1E500				
LC1E630				

## 4 Pole Accessories Compatibility

Contactor	LAEN**	LAEM	LAERC*
LC1E06	1	1	1
LC1E09			
LC1E12			
LC1E18			
LC1E25			
LC1E32			
LC1E38			
LC1E40			
LC1E50			
LC1E65			
LC1E80			
LC1E95			

## Control Relay Accessories Compatibility

Control Relay	LAEN*	LAERC
CAE	1 of LAEN11 or LAEN20 or LAEN02 or LAEN22	1

# Easy TeSys

## The performance you need

### Circuit breaker

Choose from:

- Easy TeSys GZ1E
- TeSys GV

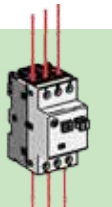

### Contactor

- Easy TeSys

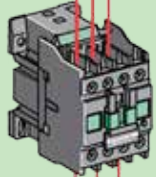

### Control Relay

- Easy TeSys

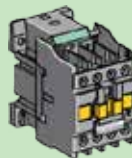

### Thermal overload relay (TOR)

- Easy TeSys

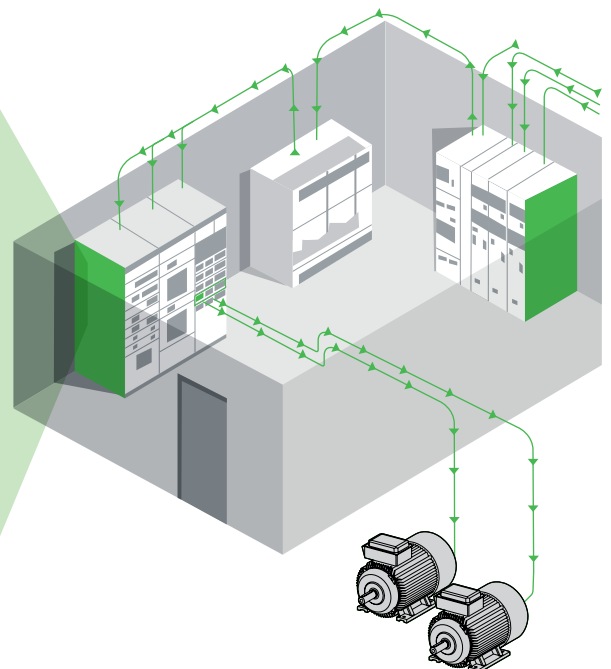
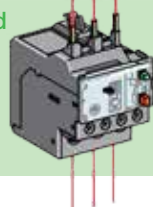

For details on non standard references, technical parameters, accessories, compatibility, stockable and non stockable status please contact Customer Care

☑ NORMAL STOCK ITEMS

W.E.F. January 15<sup>th</sup>, 2026

## Thermal Overload Relay - Easy TeSys



- Conformance to IEC 60947-4-1, CE Marking
- Range : 0.1A to 630A
- Tripping Class : 10A
- Direct & Independent mounting

Thermal Protection Adjustment Range	For Use with Contactor	Reference	Unit MRP [₹]
<b>LRE</b>			
0.25...0.4	E06...E38	LRE03	2935
0.4...0.63	E06...E38	LRE04	2935
0.63...1	E06...E38	LRE05 <input checked="" type="checkbox"/>	2935
1...1.6	E06...E38	LRE06 <input checked="" type="checkbox"/>	2935
1.6...2.5	E06...E38	LRE07 <input checked="" type="checkbox"/>	2935
2.5...4	E06...E38	LRE08 <input checked="" type="checkbox"/>	2935
4...6	E06...E38	LRE10 <input checked="" type="checkbox"/>	2935
5.5...8	E09...E38	LRE12 <input checked="" type="checkbox"/>	2935
7...10	E09...E38	LRE14 <input checked="" type="checkbox"/>	2935
9...13	E12...E38	LRE16 <input checked="" type="checkbox"/>	2935
12...18	E18...E38	LRE21 <input checked="" type="checkbox"/>	3255
16...24	E25...E38	LRE22 <input checked="" type="checkbox"/>	3610
23...32	E25...E38	LRE32 <input checked="" type="checkbox"/>	5025
30...38	E38	LRE35 <input checked="" type="checkbox"/>	5660
17...25	E40...E95	LRE322	6385
23...32	E40...E95	LRE353	6385
30...40	E40...E95	LRE355	6385
37...50	E50...E95	LRE357 <input checked="" type="checkbox"/>	6385
48...65	E65...E95	LRE359	8380

Thermal Protection Adjustment Range	For Use with Contactor	Reference	Unit MRP [₹]
<b>LRE</b>			
55...70	E80...E95	LRE361	9925
63...80	E80...E95	LRE363	10365
80...104	E95	LRE365	10365
51...81	E120...E300	LRE480	19405
62...99	E120...E300	LRE481	19405
84...135	E120...E300	LRE482	19405
124...198	E160...E300	LRE483	19405
146...234	E200...E300	LRE484	19405
174...279	E250...E300	LRE485	19405
208...333	E300	LRE486	21145
258...414	E300...E400	LRE487	25730

### Accessories for Relay

Accessory	For Relay	Reference	Unit MRP [₹]
Separate Mounting Block	LRE01...LRE35	LAEB1	1030
	LRE322...LRE365	LAEB3	2385

For details on non standard references, technical parameters, accessories, compatibility, stockable and non stockable status please contact Customer Care

NORMAL STOCK ITEMS

W.E.F. January 15<sup>th</sup>, 2026

## Circuit Breaker for Motor Protection - GZ1E - Pushbutton control



- Conformance to IEC60947-1,-2,-4, CE Marking
- Range : 0.1A to 32A
- Breaking Capacity upto 100KA

## Motor Protection Circuit Breaker - Easy TeSys

Breaking Capacity at 50 Hz		Thermal Protection Adjustment Range (A)	Reference	Unit MRP [₹]
690 V	500 V			
<b>GZ1-E Thermal Magnetic - With Pushbutton Control</b>				
100 kA	100 kA	0.1 - 0.16	GZ1E01	5495
		0.16 - 0.25	GZ1E02	5495
		0.25 - 0.40	GZ1E03	5495
		0.40 - 0.63	GZ1E04	6395
		0.63 - 1.0	GZ1E05	6395
2 kA	100 kA	1.0 - 1.6	GZ1E06	6270
		1.6 - 2.5	GZ1E07	6270
2 kA	30 kA	2.5 - 4	GZ1E08	6510
		4 - 6.3	GZ1E10	6510
2 kA	8 kA	6 - 10	GZ1E14	6940
		9 - 14	GZ1E16	7820
2 kA	5 kA	13 - 18	GZ1E20	8505
		17 - 23	GZ1E21	8970
		20 - 25	GZ1E22	9420
2 kA	3 kA	24 - 32	GZ1E32	16075

Breaking Capacity at 50 Hz		Magnetic Protection (A)	Reference	Unit MRP [₹]
690 V	500 V			
<b>GZ1-LE Magnetic- With Pushbutton Control</b>				
100 kA	100 kA	1	GZ1LE05	4015
		1.6	GZ1LE06	4015
2 kA	100 kA	2.5	GZ1LE07	4015
		4	GZ1LE08	4015
2 kA	38 kA	6.3	GZ1LE10	4015
		8 kA	GZ1LE14	4015
2 kA	5 kA	14	GZ1LE16	4335
		18	GZ1LE20	4335
2 kA	3 kA	25	GZ1LE22	4335
		32	GZ1LE32	5140

## Accessories - Easy TeSys Circuit Breaker for Motor Protection

Description	Mounting	Contacts	Reference	Unit MRP [₹]
Auxillary Contact Block	LH side Mounted	1NO+1NC	GZ1AN11	1025
		2NO	GZ1AN20	1330

## Electric Trips

Description	Mounting	Range	Reference	Unit MRP [₹]
Undervoltage	RH Side Mounted	380...400 V (50 Hz)	GZ1AU385	4530
Shunt trip		220...240 V (50 Hz)	GZ1AS225	6560

For details on non standard references, technical parameters, accessories, compatibility, stockable and non stockable status please contact Customer Care

NORMAL STOCK ITEMS

W.E.F. January 15<sup>th</sup>, 2026



years strong & still innovating!

> Control > Protect > Power > Active

### Innovative and connected solutions for motor starters

TeSys is an innovative motor control and management solution from the global market leader. TeSys offers connected, efficient products and solutions for switching and protection of motors and electrical loads in compliance with all major global electrical standards

## TeSys Function Names

TeSys components are grouped by function name, for easier identification. These functions are related to motor, power, control and protection.

### > TeSys Power:

Components for powering motors



### > TeSys Control:

Components for controlling motors



### > TeSys Protect:

Components for protecting motors

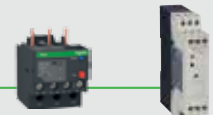

### > TeSys Active:

Connected components for motor circuits

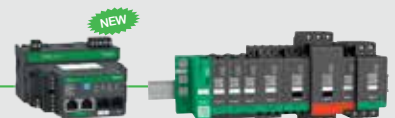



# Start smart. Run smart. With TeSys motor controls.

Stay smart with the world's best-selling motor control solutions from the inventor of the world's first contactor - Schneider Electric™.

**For over a century, TeSys motor controls have driven the industry with innovations in motor protection, monitoring, and control.**

It started with the introduction of the industry's first BAR contactor in 1924, and today, the legacy of innovation is built into every TeSys motor control device.

Best-in-class safety and reliability, plug-and-play architecture, and flexible functionality mean TeSys motor control solutions can meet your requirements across a wide range of applications, from the most common to the most advanced.

## Over A Century of Innovation and Leadership

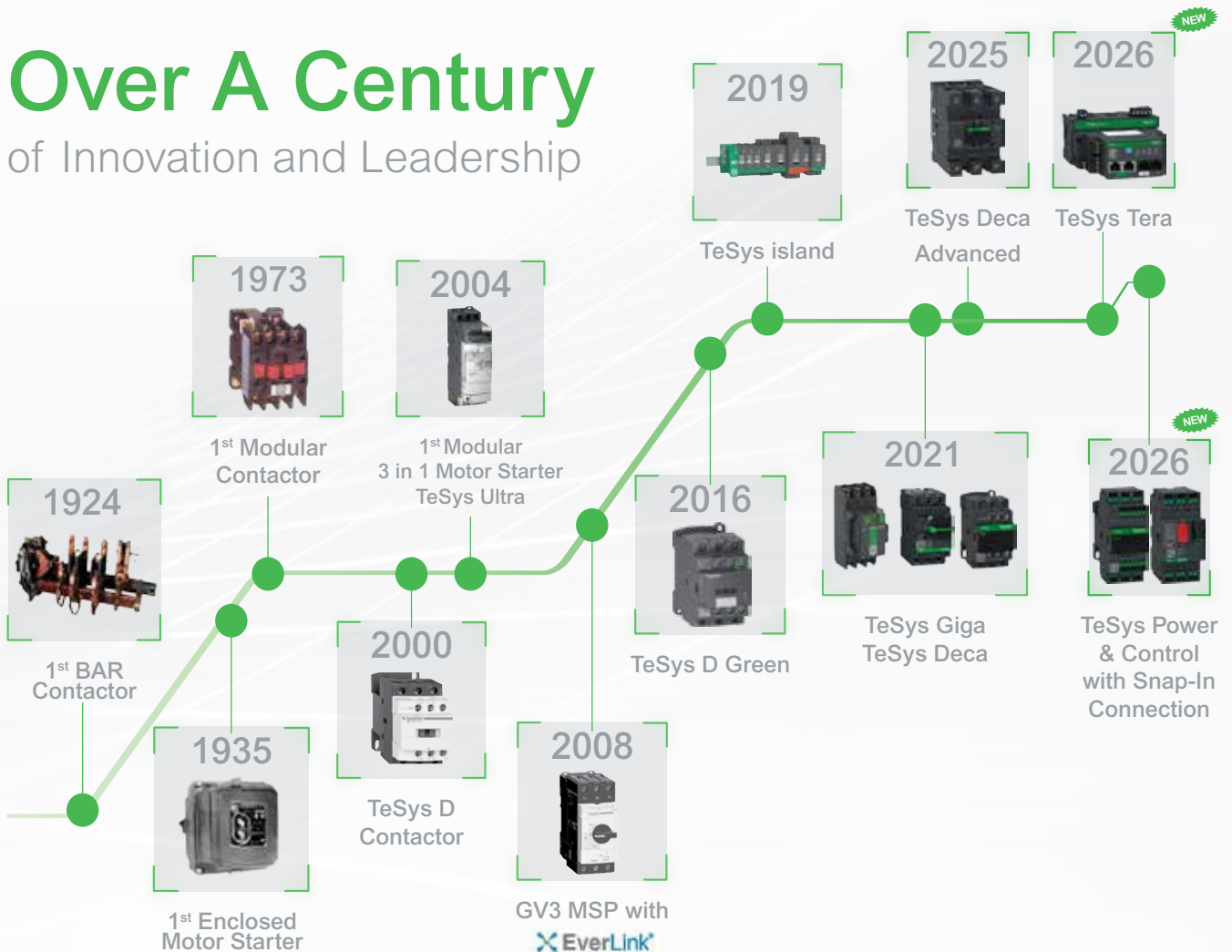

# Superior safety for all industries

TeSys motor controls come with all of the isolation, protection and emergency handling you need to comply with international codes. High-contrast covers identify safety-critical devices to prevent inadvertent manual operation. Every TeSys contactor is both mechanically linked and equipped with mirror contacts for safety applications and wherever auxiliary contact state reliability is critical.



## HVAC

Ensure 24/7 availability of your HVAC system with reliable products that can reach high ambient temperatures without derating.



## Conveying

Decentralize the control cabinet of your conveyor line and benefit from up to 80% space reduction.



## Genset

Make certain your generator starts even in the harshest conditions with robust TeSys solutions.



## Pumping

Optimize single or multi-drive boosters for industry or infrastructure with energy and cost-effective solutions.



## Packaging

Keep pace with the most demanding, high-end packing applications with solutions that can perform 30 million AC53a electrical cycles, like TeSys H.



## Oil and Gas

Keep your employees and assets safe and improve uptime in onshore and offshore applications: pipeline operations: LNG and natural gas processing: and refining and petrochemical applications.



## Water and Wastewater

Optimize the treatment and delivery of safer water by reducing energy usage and lowering operating costs.



## Food and Beverage

Serve your customers with environmentally friendly products to improve sustainability, efficiency, and flexibility, allowing you to adapt to changing customer habits.

## Online selection tool

### EcoStruxure™ Motor Control Configurator

For Direct-On-Line and Star-Delta starters, motor circuit breakers with advanced protection, motor management relays, configurations for total coordination, drives, and soft starters.

No matter what kind of starting method you need, our online EcoStruxure™ Motor Control Starter Configurator will help you to quickly and easily select the optimal combination of components to ensure maximized motor safety, protection, and uptime.

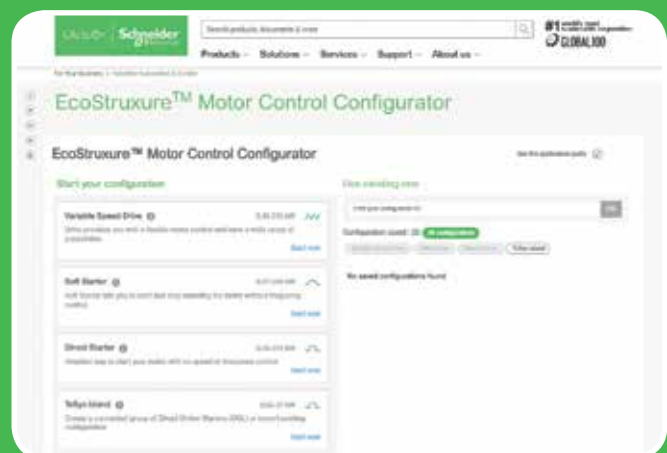

Scan or click on  
the QR code

# TeSys Range

## TeSys Component Series Names

Series names are now grouped as per the current ratings

- Series names group conventional components (circuit breakers, contactors, relays, overcurrent relays) by current rating ranges.
  - 0 to 16 A > **TeSys K Series**
  - 9 to 150 A > **TeSys 'Deca' Series**
  - 185 to 800 A > **TeSys 'Giga' Series**.
- TeSys advanced components have a specific classification.
  - 0 to 38 A All-in-one starters > **TeSys 'Ultra' Series**
  - 0 to 80 A Motor Control/Protection/Monitoring system > **TeSys 'island' Series**.

### > TeSys K Series

The essential line for motors up to 7.5kW/16A direct on TeSys K series of Motor Starters



### > TeSys Deca Series

The industrial standard for motors up to 75kW/150A direct on TeSys Deca series of Motor Starters



### > TeSys Giga Series

For large motors up to 450kW/800A direct on TeSys Giga Series



### > TeSys Ultra Series

The most compact totally coordinated solution for Motor Starters. For Direct On Line or Reversing Motor Control and Drive Protection upto 18.5kW/38 A on TeSys Ultra series



### > TeSys Island Series

Digitally powered monitoring, control and protection of electrical motors up to 37kW/80 A on TeSys Island Series



# TeSys Control

## TeSys K

### Control Relays - K Model (AC & DC Control)



- Conformance IEC, UL, CSA, CE Marking
- Inbuilt 4 auxiliary contacts
- 10A thermal rating
- Available with AC (50/60Hz Dual frequency), DC & DC low consumption coil options

No of Poles	AC Control Reference	Unit MRP [₹]				DC Control Reference <sup>(4)</sup>	Unit MRP [₹]		
		B7 (24V)	F7 (110V)	M7 (220V)	N7 (415V)		BD (24V)	FD (110V)	MD (220V)
2NO + 2NC	CA2KN22*	2420	2420	2420	2420	CA3KN22**	3365	3365	3365
3NO + 1NC	CA2KN31*	2420	2420	2420	-	CA3KN31**	3365	3365	3365
4NO	CA2KN40*	2420	2420	2420	2890				

No of Poles	DC low consumption Reference <sup>(1) (2) (3)</sup>	Unit MRP [₹]		
		BW3 (24V)	EW3 (48V)	SW3 (72V)
2NO + 2NC	CA4KN22***	4125	4945	4125
3NO + 1NC	CA4KN31***	4125	5118	-
4NO	CA4KN40***	4125	4945	-

For other coil voltage ratings regarding above, please contact Schneider Electric customer care.

\* Reference to be completed by adding coil voltage code

- (1) Compatible with PLC outputs  
 (2) Wide range coil (0.7...1.25Uc), suppressor fitted as standard  
 (3) 2 pole auxiliary contact block can be mounted additionally  
 (4) Optional in-built surge suppressor available

### Power Contactors - K Model (3 Pole AC & DC Control)



- Conformance to IEC, UL, CSA
- Current Rating : 6A to 16A, AC-3 duty
- 1NO or 1NC inbuilt auxiliary contact
- Available in 3P & 4P version
- Available with AC (50/60Hz Dual frequency), DC & DC low consumption<sup>(5)</sup> coil options

Motor Power (kW)	Auxiliary Contacts	AC Control Reference	Unit MRP [₹]				DC Control Reference <sup>(5)</sup>	Unit MRP [₹]		
			B7 (24V)	F7 (110V)	M7 (220V)	N7 (415V)		BD (24V)	FD (110V)	MD (220V)
3	1NC	LC1K0601*	2105	2105	2105	2560	LP1K0601**	3290	3975	-
	1NO	LC1K0610*	2105	2105	2105	2105	LP1K0610**	3290	3975	-
5.5	1NC	LC1K0901*	2200	2200	2200	2660	LP1K0901**	3575	3575	3575
	1NO	LC1K0910*	2200	2200	2200	2200	LP1K0910**	3575	3575	3575
7.5	1NC	LC1K1201*	2490	2490	2490	-	LP1K1201**	4145	-	-
	1NO	LC1K1210*	2490	2490	2490	3000	LP1K1210**	4145	5015	5075
10	1NC	LC1K1601*	2945	2945	2945	-	-	-	-	-
	1NO	LC1K1610*	2945	2945	2945	-	-	-	-	-

For other coil voltage ratings contactors, please contact Customer Care.

\* Reference to be completed by adding coil voltage code

(5) For low consumption offer, please contact Customer Care

### Reversing Contactors - K Model



- Conformance to IEC, UL, CSA, CE
- Current Rating : 6A to 16A, AC-3 duty
- 1NO or 1NC inbuilt auxiliary contact
- Available in 3P & 4P version
- Available with AC(50/60Hz Dual frequency), DC & DC low consumption<sup>(6)</sup> coil options

Motor Power (kW)	Auxiliary Contacts	AC Control Reference	Unit MRP [₹]	
			F7 (110V)	M7 (220V)
3	1 NC	LC2K0601*	7010	7010
	1 NO	LC2K0610*	7010	7010
5.5	1 NC	LC2K0901*	7480	7480
	1 NO	LC2K0910*	7480	7480
7.5	1 NC	LC2K1201*	8046	8046
	1 NO	LC2K1210*	7710	7710
10	1 NC	LC2K1601*	10355	10355
	1 NO	LC2K1610*	8610	10355

For other coil voltage ratings contactors, please contact Customer Care.

\* Reference to be completed by adding coil voltage code

(6) For current rating and ref please contact Customer Care

For details on non standard references, technical parameters, accessories, compatibility, stockable and non stockable status please contact Customer Care

NORMAL STOCK ITEMS

W.E.F. January 15<sup>th</sup>, 2026

# TeSys Control

## TeSys K

### Accessories - K Model

Description	Mounting	Contacts	Reference	Unit MRP [₹]
Auxiliary contact block	Front	2NC	LA1KN02	1160
	Front	1NO + 1NC	LA1KN11 <input checked="" type="checkbox"/>	1060
	Front	2NO	LA1KN20	1160
	Front	4NC	LA1KN04	1785
	Front	1NO + 3NC	LA1KN13	1785
	Front	2NO + 2NC	LA1KN22 <input checked="" type="checkbox"/>	1785
	Front	3NO + 1NC	LA1KN31	1785
	Front	4NO	LA1KN40	1785

Description	Control Voltage	Range	Reference	Unit MRP [₹]
On Delay Electronic Timer	24..48 V AC/DC	1..30S	LA2KT2E	5845
	110..240 V AC	1..30S	LA2KT2U	5845

Description	Coil Voltage	Reference	Unit MRP [₹]
Surge Suppressor - RC Circuit	220..250V AC	LA4KA1U*	1535
Surge Suppressor - Varistor	130..250V AC/DC	LA4KE1UG*	1535
Surge Suppressor - Varistor	50..129V AC/DC	LA4KE1FC*	1535

\* Lot size 5

(1) Front mounted with common point changeover contact

For details on non standard references, technical parameters, accessories, compatibility, stockable and non stockable status please contact Customer Care

NORMAL STOCK ITEMS

W.E.F. January 15<sup>th</sup>, 2026

# TeSys Capacitor Duty Contactor

## Capacitor Duty Contactor



Nominal Reactive Power 440V	Auxiliary Contacts	Reference	Unit MRP [₹]	
			F7 (110 V)	M7 (220V)
<b>LC1-D•K - with Damping Resistors &amp; Block of Early Make poles</b>				
12.5 kVar	1NO + 2NC	LC1DFK*	7070	7070
16.7 kVar	1NO + 2NC	LC1DGK*	9930	9930
20 kVar	1 NO + 2 NC	LC1DLK	11155	-
25 kVar	1NO + 2NC	LC1DMK*	12235	12235
32 kVar	1 NO + 2NC	LC1DPK*	26655	26655
40 kVar	1NO + 2NC	LC1DTK*	36720	36720
60 kVar	1NO + 2NC	LC1DWK12*	41335	41335

For other coil voltage ratings contactors, please contact Customer Care.

\* Reference to be completed by adding coil voltage code



### Guide for the Design and Production of LV Power Factor Correction Cubicles

For complete information  
on selection of capacitor  
switching please refer to the  
TeSys catalogue

For details on non standard references, technical parameters, accessories, compatibility, stockable and non stockable status please contact Customer Care

NORMAL STOCK ITEMS

W.E.F. January 15<sup>th</sup>, 2026

# TeSys Control

## TeSys Deca

The next-generation TeSys Deca series motor starters offer a reliable and robust solution for a faster machine time-to-market. It has a new modern look & feel and is designed to meet the requirements of Electro domestic applications. Ease of operation and reliability is guaranteed with the new multi-standard screws. Digital customer experience is enhanced with a QR embedded from product to packaging.

### TeSys Deca Control Contactors (AC & DC Control)



- Conformance to IEC, UL, CSA
- 5 inbuilt auxiliary contacts, in just 2 variants
- Available with AC (50/60Hz Dual frequency), DC & DC low consumption coil options
- High Operating ambient temperature upto 60 Deg C
- Inbuilt surge suppressor for DC & DC low consumption

No of Poles	AC Control Reference	Unit MRP [₹]				DC Control Reference <sup>(4)</sup>	Unit MRP [₹]		
		B7 (24V)	F7 (110V)	M7 (220V)	N7 (415V)		BD (24V)	FD (110V)	MD (220V)
3NO + 2NC	CAD32*	2485	2485	2485	2485	CAD32**	3575	3575	3575
5NO	CAD50*	2485	2485	2485	-	CAD50**	3575	3575	3575

No of Poles	DC low consumption Reference <sup>(1) (2) (3)</sup>	Unit MRP [₹]		
		BL (24V)	FL (110V)	ML (220V)
3NO + 2NC	CAD32***	4470	5360	7575
5NO	CAD50***	4470	5360	4470

For other coil voltage ratings contactors, please contact Customer Care.

\* Reference to be completed by adding coil voltage code

(1) Compatible with PLC outputs

(2) Wide range coil (0.7...1.25Uc), suppressor fitted as standard

(3) 2 pole auxiliary block can be mounted

### Power Contactors - Deca Model (3 Pole AC & DC Control)



- Conformance to IEC, UL, CSA
- Available with AC (50/60Hz Dual frequency), DC & DC low consumption coil options
- High Operating ambient temperature, no derating upto 60 Deg C
- Inbuilt 1NO + 1NC auxiliary contacts upto 150A
- High electrical and mechanical life
- Fuse-less Type 2 Co-ordination Charts available
- EverLink® terminal for 40, 50, 65 & 80A contactors
- Inbuilt surge suppressor in DC coil for 9-80A

[le] Rated Operational Current AC-1	kW	AC-3 Duty			Auxiliary Contacts	AC Control Reference	Unit MRP [₹]		
		HP	A				M7 (220V)	N7 (415V)	F7 (110V)
25	4	5.5	9	1 NO + 1 NC	LC1D09*	2475	2475	2475	
25	5.5	7.5	12	1 NO + 1 NC	LC1D12*	2790	2790	2790	
32	9	12.5	18	1 NO + 1 NC	LC1D18*	3235	3235	3235	
40	11	15	25	1 NO + 1 NC	LC1D25*	4020	4020	4020	
50	15	20	32	1 NO + 1 NC	LC1D32*	7820	7820	7820	
50	18.5	25	38	1 NO + 1 NC	LC1D38*	11120	11120	11120	
60	22	30	40	1 NO + 1 NC	LC1D40A*	11895	11895	11895	
80	25	35	50	1 NO + 1 NC	LC1D50A*	15420	15420	15420	
80	37	50	65	1 NO + 1 NC	LC1D65A*	21395	21395	21395	
80	37	50	80	1 NO + 1 NC	LC1D80A	26745	26745	26745	
125	45	60	80	1 NO + 1 NC	LC1D80*	33065	33065	33065	
125	45	60	95	1 NO + 1 NC	LC1D95*	34440	34440	34440	
250	59	80	115	1 NO + 1 NC	LC1D115*	48750	48750	48750	
250	80	110	150	1 NO + 1 NC	LC1D150*	55905	55905	55905	

For other coil voltage ratings contactors, please contact Customer Care.

\* Reference to be completed by adding coil voltage code

For details on non standard references, technical parameters, accessories, compatibility, stockable and non stockable status please contact Customer Care

☑ NORMAL STOCK ITEMS

W.E.F. January 15<sup>th</sup>, 2026

# TeSys Control

## TeSys Deca

### TeSys Deca Power Contactors (3 Pole DC Low Consumption)

Now available upto 80A with the TeSys Deca Advanced Low Consumption offer

[Ie] Rated Operational Current AC1	Motor Power (Long Life) AC3			Auxiliary Contacts	Reference	Unit MRP [₹]	
	kW	HP	A			BL (24V)	EL (48V)
25	4	5.5	9	1 NO + 1 NC	LC1D09**** <input checked="" type="checkbox"/>	4315	4315
25	5.5	7.5	12	1 NO + 1 NC	LC1D12**** <input checked="" type="checkbox"/>	4830	4830
32	9	12.5	18	1 NO + 1 NC	LC1D18**** <input checked="" type="checkbox"/>	7380	7380
40	11	15	25	1 NO + 1 NC	LC1D25**** <input checked="" type="checkbox"/>	8990	8990
50	15	20	32	1 NO + 1 NC	LC1D32**** <input checked="" type="checkbox"/>	15380	15380

For other coil voltage ratings contactors, please contact Customer Care.

\* Reference to be completed by adding coil voltage code

### TeSys Deca Power Contactors (4 Pole AC & DC Control)



- Conformance to IEC, UL, CSA
- Available with AC (50/60Hz Dual frequency), DC & DC low consumption<sup>(1)</sup> coil options
- High Operating ambient temperature, no derating upto 60 deg C

[Ie] Rated Operational Current AC1	Poles Composition	AC control Reference	Unit MRP [₹] M7 (220V)	DC control Reference	Unit MRP [₹]		
					BD (24V)	FD (110V)	MD (220V)
20	4NO	-	-	LC1DT20**	4735	4735	4735
	2NO+2NC	-	-	LC1D098**	5155	5155	5155
25	4NO	-	-	LC1DT25**	5690	5690	5690
	2NO+2NC	-	-	LC1D128**	7425	7425	7425
32	4NO	-	-	LC1DT32**	6250	10600	7495
	2NO+2NC	-	-	LC1D188**	8455	10120	8455
40	4NO	-	-	LC1DT40**	9800	9800	9800
	2NO+2NC	-	-	LC1D258**	12920	12920	12920
60	2NO+2NC	-	-	LP1D40008**	25775	30890	25775
80	2NO+2NC	-	-	LP1D65008**	34655	34655	-
125	4NO	-	-	LP1D80004**	37540	44975	-
	2NO+2NC	-	-	LP1D80008**	43310	51885	43310

**Note:** Please contact Customer Care for 4 Pole AC coil contactor details

<sup>(1)</sup> For current rating and ref please contact Customer Care

For other coil voltage ratings contactors, please contact Customer Care.

\* Reference to be completed by adding coil voltage code

For details on non standard references, technical parameters, accessories, compatibility, stockable and non stockable status please contact Customer Care

NORMAL STOCK ITEMS

W.E.F. January 15<sup>th</sup>, 2026



## TeSys Control Motor Switching Solutions with Fast and Reliable SNAP IN Connections up to 32 amp (AC-3/AC-3e)



Spring-type terminals are now upgraded to **SNAP IN** connections  
- delivering a more robust, reliable, and user-friendly solution!

### TeSys Deca Power Contactors



It's so **QUICK**  
as one second

- Up to 92% time saving compared with other connection technology

### TeSys Deca Control Contactors



### TeSys Deca Motor Contactors SNAP IN Type

LC1D	09	A*	CAD	32	A*
Power Contactor TeSys Deca series, 3P	AC-3/AC-3e Rating 09: 09 amp 12: 12 amp 18: 18 amp 25: 25 amp 32: 32 amp	Main Terminal 3: Spring ↓ Getting Replaced with A: SNAP IN <b>NEW</b>	Control Contactor TeSys Deca series	No. of Poles 32: 3NO+2NC 50: 5NO	Main Terminal 3: Spring ↓ Getting Replaced with A: SNAP IN <b>NEW</b>

**Note:** \* Reference to be completed by adding coil voltage code  
For coil voltage ratings contactors, please contact the respective sales representative

For price details, please contact the respective sales representative.

# Simplicity with just 1 click for 1 second

It's so **EASY** as one hole, one pusher, one click.

- No special tool skills needed.
- No wiring tool needed regardless of flexible, solid or fine-stranded conductors



## Simplicity It's so QUICK!

- Electrical connection under one second
- Up to 92% faster than traditional technologies

## Scalability READY-TO-ROBOT!

- The first contactor suitable for fully automatic mounting and wiring.

## Scalability Comprehensive solution!

- Up to 32 amp (AC-3/AC-3e) motor switching solution thanks to extensive accessories

## Simplicity It's so EASY!

- The world's first self-explanatory clamping technology. One hole, one pusher, one click.
- Solid and flexible wires with or without cable end can be connected without any tools.

## Reliability It's so SECURE!

- Your peace of mind with every connection through, a clearly audible click and the pusher moves forwards.

## Reliability General benefits

- Each connection has a testing point for diagnostics
- Maintenance-free clamping technology
- One-handed unwiring



NEW



# Reliability from install to maintain

## It's so SECURE

- Clear indication by a sound and visual feedback as confirmation to the electricians

 <p><b>Delivery status</b></p>	 <p><b>Wiring</b></p>	 <p><b>Clamping</b></p>
<p>The device is supplied with a preloaded spring. The switching status of the preloaded terminal point is indicated by the position of the pusher.</p>	<p>The stripped wire can be easily and securely inserted into the terminal point without any further preparation.</p>	<p>When the wire touches the ground contact of the terminal, the spring of the clamping point is released and shoots the terminal. This changes the position of the pusher and a clear 'click' can be heard.</p>

## Reliability benefits the whole customer journey

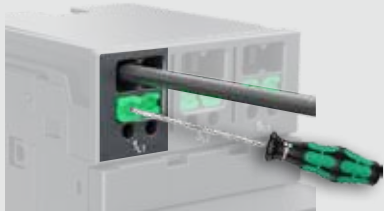
<p><b>Testing</b></p>	<p><b>Operation</b></p>	<p><b>Maintenance</b></p>
<p>Measuring point of each connection</p>	<p>Maintenance-free clamping technology</p>	<p>One-handed unwiring</p>
<p>Ideal for final acceptance tests as well as maintenance &amp; service</p>  <p>Safety of Your Machines Depend on Smart Solutions</p>	<p>Robust against vibrations and shocks</p>  <p>Continuous pressure force</p>	<p>First reset all pushers. Then all wires can then be removed without using any force.</p> 



# TeSys Deca Advanced

## The Revolutionary Electronic Coil Contactor



Complete range in 4 frame sizes:

09-12-18A

25-32-38A

40-50-65-80A

115-150A **NEW**

 -80%

Up to 80% less energy consumption than a traditional electromechanical motor starter

10X Reduction  
in references

Few set of references covering the complete voltage range for AC and DC

 -35%

Small in size & high current handling capacity

PLC Compatible

Direct connection to a PLC without the need for an interposing relay

SEMIF47

High uptime thanks to wide band coil with high resistance to voltage surges/SEMIF47 conform



Scan to see TeSys Deca Advanced under voltage performance.

# TeSys Control

## Deca Advanced Contactors

### Introduction

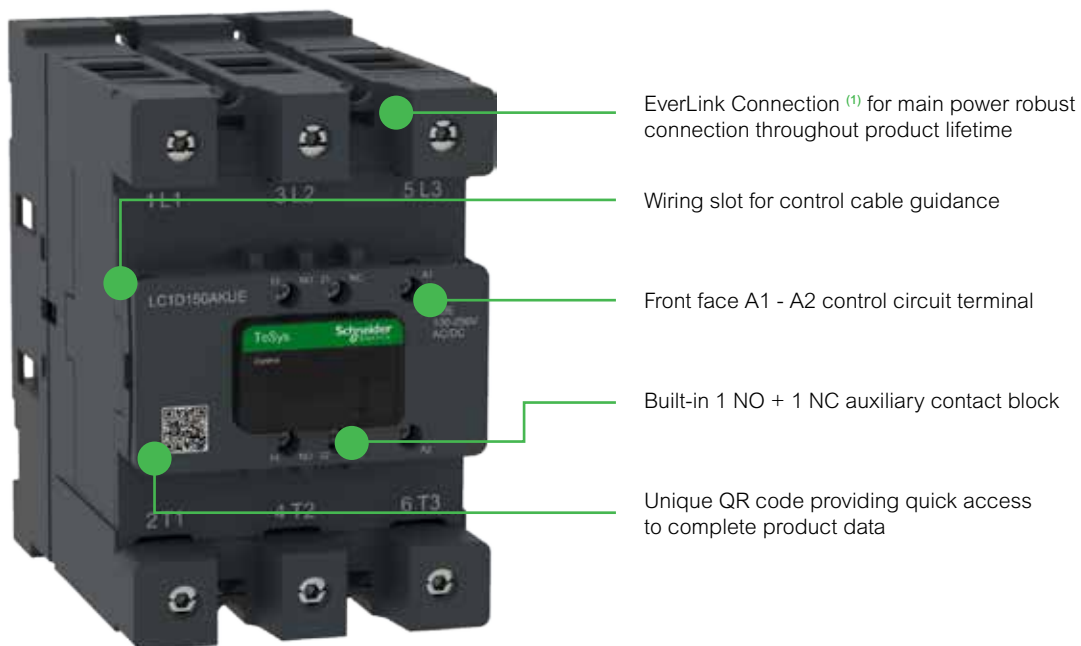

### TeSys Deca Advanced contactors



9...18 A



25...38 A



40...80 A



115...150 A

#### Power & switch

- 3 or 4 power poles
- 9 to 150 A (AC-3/AC-3e)
- 25 to 200 A (AC-1)
- Embedded 1 NO + 1 NC auxiliary contacts
- Patent EverLink main power terminals <sup>(1)</sup>

#### Efficient design

- Low consumption coils
- High rating within compact size
- Ready for IE3/IE4 high efficiency motor

#### Remote control

- 24V DC <sup>(2)</sup>, 24...60 V, 48...130 V 100...250 V, 200...500 V AC/DC coils
- PLC direct control available <sup>(3)</sup>
- High resistance to voltage fluctuation
- Embedded surge suppressor

#### Standards & Certifications

- Multiple standards
- International certifications

<sup>(1)</sup> for LC1D40A...150A

<sup>(2)</sup> BBE coil for LC1D40A...80A for PLC direct input

<sup>(3)</sup> BNE coil for LC1D09...38, BBE coil for LC1D40 A...80A

# TeSys Control

## Deca Advanced Contactors

### TeSys Deca Advanced Contactors



**LC1**

**Contactor**

TeSys Deca  
Advanced  
series, 3P

**D**

**09**

**AC3 Rating**

09: 09 A  
12: 12 A  
18: 18 A  
25: 25 A  
32: 32 A  
38: 38 A  
40: 40 A  
50: 50 A  
65: 65 A  
80: 66 A  
115: 115 A **NEW**  
150: 150 A **NEW**

**A(6)**

**Main Terminal**

Blank: Screw  
A: EverLink  
+6: Lug

**KUE**

**Coil voltage (AC/DC)**

BBE<sup>(1)</sup>: 24 V DC  
BNE: 24...60 V AC/DC  
EHE: 48...130 V AC/DC  
KUE: 100...250 V AC/DC  
LSE<sup>(2)</sup>: 200...500 V AC/DC

(1) BBE only for LC1D40A...D80A  
(2) LSE only for LC1D115A...D150A

**LC1**

**Contactor**

TeSys Deca  
Advanced  
series, 4P

**DT**

**200**

**AC3 Rating**

60: 60 A  
80: 80 A  
200: 200 A **NEW**

**A(6)**

**Main Terminal**

A: EverLink  
+6: Lug

**KUE**

**Coil voltage (AC/DC)**

BBE<sup>(3)</sup>: 24 V DC  
BNE: 24...60 V AC/DC  
EHE: 48...130 V AC/DC  
KUE: 100...250 V AC/DC  
LSE<sup>(4)</sup>: 200...500 V AC/DC

(3) BBE only for LC1DT60A...DT80A  
(4) LSE only for LC1DT200A

# TeSys Control

## Deca Advanced Contactors

### TeSys Deca Advanced Contactor (3 Pole AC/DC Universal Coil)



- Universal AC/DC coil from 24 - 250V
- Special low consumption offer from 40-80A
- Fuseless Type 2 Co-ordination charts available

### The Revolutionary Electronic Coil Contactor

[le] Rated Operational Current AC1	AC3 Duty (Long Life)			Auxiliary Contacts	Reference	Unit MRP [₹]			
	kW	HP	A			BNE (24-60V AC/DC)	EHE (48-130V AC/DC)	KUE (100-250V AC/DC)	LSE (200-250V AC/DC)
25	4	5.5	9	1 NO + 1 NC	LC1D09	5304	5304	5125	-
25	5.5	7.5	12	1 NO + 1 NC	LC1D12	5315	5315	5315	-
32	9	12.5	18	1 NO + 1 NC	LC1D18	7010	7010	7254	-
40	11	15	25	1 NO + 1 NC	LC1D25	8370	8370	8370	-
50	15	20	32	1 NO + 1 NC	LC1D32	17005	17005	17005	-
50	18.5	25	38	1 NO + 1 NC	LC1D38	18350	21795	18350	-
60	22	30	40	1 NO + 1 NC	LC1D40A	19875	19875	19875	-
80	25	35	50	1 NO + 1 NC	LC1D50A	24945	24945	24945	-
80	37	50	65	1 NO + 1 NC	LC1D65A	28290	28290	28290	-
60	37	50	80	1 NO + 1 NC	LC1D80A	34335	34335	34335	-
80	22	30	40	1 NO + 1 NC	LC1D40A	19875	19875	19875	-
80	25	35	50	1 NO + 1 NC	LC1D50A	24945	24945	24945	-
80	37	50	65	1 NO + 1 NC	LC1D65A	28290	28290	28290	-
250	59	80	115	1 NO + 1 NC	LC1D115A <span style="color: green;">NEW</span>	44120	44665	45755	47110
250	80	110	150	1 NO + 1 NC	LC1D150A <span style="color: green;">NEW</span>	46915	48270	45455	49200

For other coil voltage ratings contactors, please contact Customer Care.  
\* Reference to be completed by adding coil voltage code

### TeSys Deca Advanced Power Contactors (4 Pole AC & DC Control)

[le] Rated Operational Current AC-1	Poles Composition	Auxiliary Contacts	AC & DC Control Reference	BBE (24V DC only)	Unit MRP [₹]			
					BNE (24-60V AC/DC)	EHE (48-130V AC/DC)	KUE (100-250V AC/DC)	LSE (200-250V AC/DC)
60	4NO	1NO + 1NC	LC1DT60A	19615	19615	19615	19615	-
80	4NO	1NO + 1NC	LC1DT80A	29260	29260	29260	29260	-
200	4NO	1NO + 1NC	LC1DT200A <span style="color: green;">NEW</span>	-	54875	58630	58215	61275

### Coil Voltage Code

Type	Voltage	24-60V AC/DC	48-130V AC/DC	100-250V AC/DC	200-250V AC/DC
AC/DC*	LC1D09 - D38, LC1D40A - 80A, LC1DT60A - 80A	BNE	EHE	KUE	
	LC1D115A - 150A <span style="color: green;">NEW</span>	BNE	EHE	KUE	LSE
24V DC Low Consumption*	LC1D40A - 80A, LC1DT60A - 80A	BBE (24V DC only)		-	-

For other coil voltage ratings contactors, please contact Customer Care.  
\* Reference to be completed by adding coil voltage code



Check the features of the TeSys Deca Advanced

For details on non standard references, technical parameters, accessories, compatibility, stockable and non stockable status please contact Customer Care

NORMAL STOCK ITEMS

W.E.F. January 15<sup>th</sup>, 2026

# TeSys Control

## Deca Advanced Contactors

### Introduction

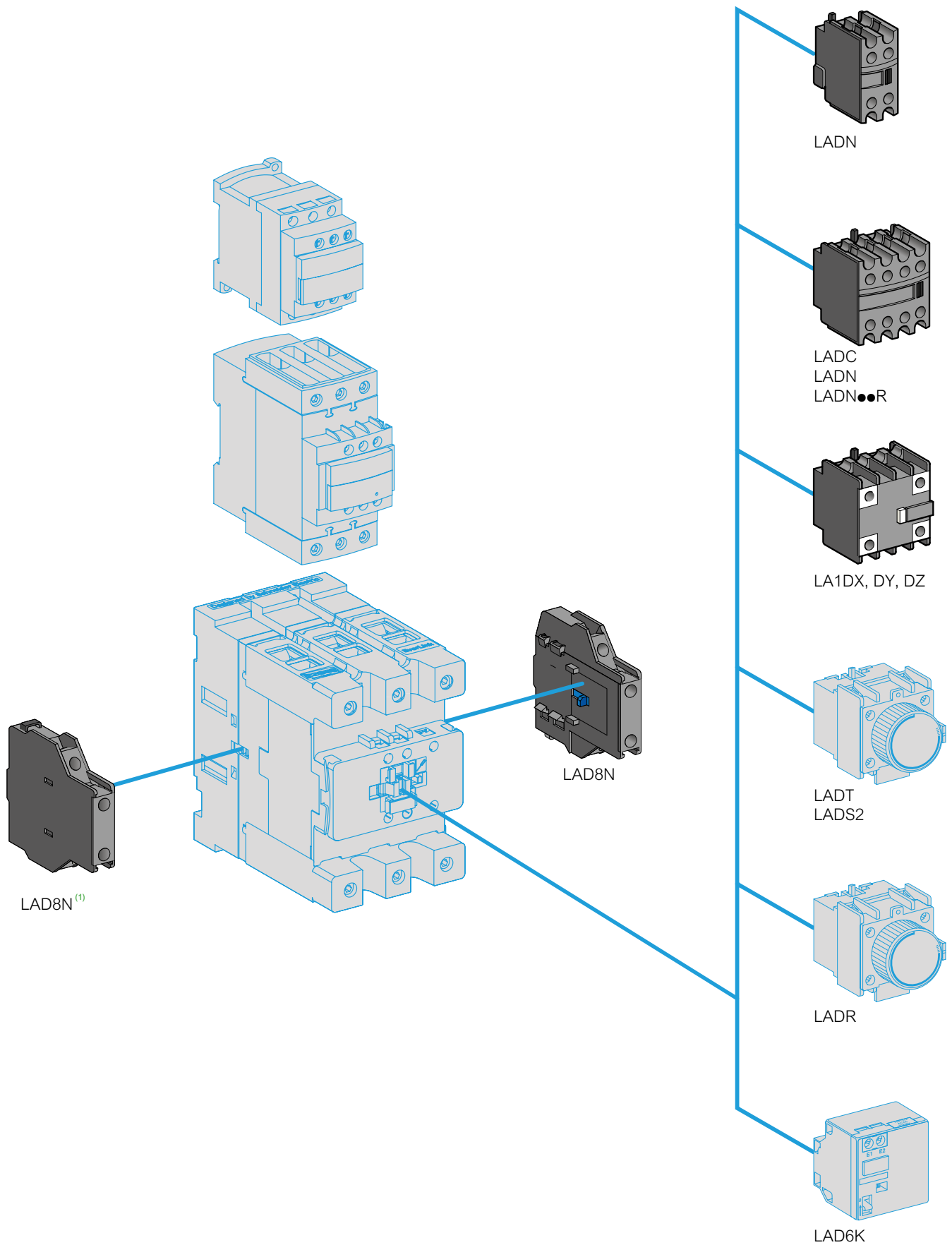

(1) No left side mounting on Deca Advanced contactors up to LC1D38.

# TeSys Control

## TeSys Deca

Description	For use with	Reference	Unit MRP [₹]
<b>Power connection accessories</b>			
Terminal block	For supply to one or more GV2 G busbar sets	GV1G09	3130
Set of 63A busbars for parallelling of contactors	2 contactors LC1D09...D18 or D25...D38	GV2G245	3065
	4 contactors LC1D09...D18 or D25...D38	GV2G445	4820
Set of 115A busbars for parallelling of contactors	2 contactors LC1D40A...D80A	GV3G264	5505
	3 contactors LC1D40A...D80A	GV3G364 <sup>(1)</sup>	2940
Set of S-shape busbars	For circuit breakers GV3P** & GV3L** and contactors LC1 D40A...D65A	GV3S	2205

\*\*Not applicable for GV3P/GV3L 73A and 80A



GV2G245



GV1G09

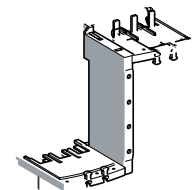

GV3S

Description	For use with	Reference	Unit MRP [₹]
Mechanical interlock	LC1D09 to D38(1)	LAD9V2	1100
	LC1D40A to D65A(1)	LAD4CM	2235
	LC1D80 and D95 ( for AC control voltage)	LA9D4002	4900
	LC1D80 and D95 (for DC control voltage)(2)	LA9D8002	7295
	LC1D115 and D150(2)	LA9D11502	7395

(1) With this set of busbars, any one contactor can be supplied directly by its EverLink® double cage power terminal block. The other two contactors are supplied by the busbar set. The 115A limitation is therefore applied to these two contactors.

(2) With electrical interlock

Description	For use with	Reference	Unit MRP [₹]
<b>Power Connection for Reversing</b>			
Kit Comprising :	LC1D09 to D38	LAD9V5	915
1. A set of parallel bars	LC1D09 to D38	LAD9V6	1145
2. A set of reverser bars.	LC1D40A to D80A	LA9D65A69	4755
	LC1D80 and D95 ( for AC control voltage)	LA9D8069	10180
	LC1D80 and D95 (for DC control voltage)	LA9D8069	10180
	LC1D115 and D150	LA9D11569	16935

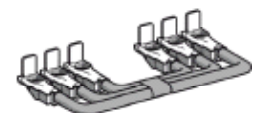
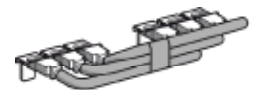

LA9 D8069

Description	For use with	Reference	Unit MRP [₹]
<b>Reversing Kit</b>			
Kit Comprising :			
1. A mechanical interlock LAD 9V2 with electrical interlocking LAD 9V1	LC1D09 to D38	LAD9R1V	2285
2. A set of power connections LAD 9V5 (parallel) and LAD 9V6 (reversing).			
Kit Comprising :			
1. A mechanical interlock LAD 9V2 without electrical interlocking	LC1D09 to D38	LAD9R1	2295
2. A set of power connections LAD 9V5 (parallel) and LAD 9V6 (reversing).			
Kit Comprising :			
1. A mechanical interlock LAD 4CM	LC1D40A to D80A	LAD9R3	5430
2. A set of power connections LA9 D65A69.			

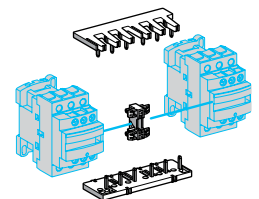

LAD9R1

Description	For use with	Reference	Unit MRP [₹]
<b>Star Delta Kit</b>			
Time delay contact block LAD S2 (LC1D09...D80),	LC1D09 and D12	LAD91217	8590
Power circuit connections (LC1D09...D80),	LC1D18 to D32	LAD93217	11045
Hardware required for fixing the contactors onto the mounting plate (LC1D80)	LC1D40A and D50A	LAD9SD3	22320
	LC1D80	LA9D8017	24785

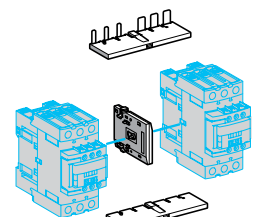

LAD9R3

Description	For use with	Reference	Unit MRP [₹]
EverLink® terminal block for independent mounting	LC1D40A to D80A	LAD96560	4130



LAD91217



LAD9SD3



LA9D8017



LAD96560

For details on non standard references, technical parameters, accessories, compatibility, stockable and non stockable status please contact Customer Care

✓ NORMAL STOCK ITEMS

W.E.F. January 15<sup>th</sup>, 2026

# TeSys Control

## TeSys Deca

Description	Time Delay Range	Timer Type	Reference	Unit MRP [₹]
On delay timer <sup>(1) (2)</sup>	15...30 s	on delay	LA4DT2U	8335
On delay timer <sup>(1) (2)</sup>	0.1...2 s	on delay	LA4DT0U	8335
On delay timer <sup>(1) (2)</sup>	25...500 s	on delay	LA4DFB	7675
Relay interface module - 24V DC <sup>(1) (2)</sup>	-	-	LA4DT4U	9335

(1) For LC1 D09...38A (3P, AC coils only) add mounting adaptor LAD4BB and for LC1 D40A...65A (3P, AC coils only), add mounting adaptor LAD4BB3.  
 (2) For LC1D80...150 (3P), direct mounting, for 100-250V AC Coils only.

Description	For use with	Reference	Unit MRP [₹]				
			B (24V) (AC/DC)	E (42/48V) (AC/DC)	F (110/127V) (AC/DC)	M (220/240V) (AC/DC)	Q (380/415V) (AC/DC)
<b>TeSys Deca Model Mechanical Latch Blocks</b>							
Front, Clip-on	LC1D09...D38 (a or c) LC1DT20...DT40 (a or c) LC1D40A...D65A (3P a or c) LC1DT60A and DT80A (4P a or c)	LAD6K10*	10015	10015	10015	10015	-
	LC1D80...D150 (3P a) LC1D80 and D115 (3 P c) LC1D80 (4 P a) LC1D80 and D115 (4 P a) LP1D80 and LC1D115 (4 P c)	LA6DK20*	10450	11725	11725	16470	14160

\* Reference to be completed by adding coil voltage code and recommended to check availability with Customer Care team

### Spare Coils TeSys Deca Model

Product Compatibility	Reference
<b>AC Coils</b>	
CAD, LC1-D09...D38, DT20..40	LXD1*
LC1D40A, D50A, D65A & LC1DT60A, DT80A	LXD3*
D80 & D95 (3P & 4P)	LX1D6*
LC1-D115, D150	LX1D8*
<b>DC Coils</b>	
LC1-D80-D95	LX4D7**
LC1-D115, D150	LX4D8**

\* Reference to be completed by adding coil voltage code and recommended to check availability with Customer Care team

### Coil Voltage Code

Type	Voltage (V)	24	110	220	415
AC*	CAD, LC1-D09...D38, DT20..40, LC1 - D150, LC1D40A, D50A, D65A & LC1DT60A, DT80A, LC1D150 LC1D80, D95, D115	B7	F7	M7	N7

For details on non standard references, technical parameters, accessories, compatibility, stockable and non stockable status please contact Customer Care

NORMAL STOCK ITEMS

W.E.F. January 15<sup>th</sup>, 2026

### Accessories

Description	For use With	Contacts	Reference	Unit MRP [₹]	
<b>Add On Blocks</b>					
Additional instantaneous auxiliary contact blocks	LC1D09 ...LC1D150*	Front Mounted 1NO + 1NC	LADN11	735	
		Front Mounted 2NO	LADN20 ✓	735	
		Front Mounted 2NC	LADN02	1185	
		Front Mounted 2NO + 2NC	LADN22 ✓	1340	
		Front Mounted 4NC	LADN04	1960	
		Front Mounted 4NO	LADN40 ✓	1340	
		Front Mounted 1NO + 3NC	LADN13	1340	
		Front Mounted 3NO + 1NC	LADN31 ✓	1340	
		LC1D80..LC1D95	Front Mounted 1NO	LADN10	655
			Front Mounted 1NC	LADN01	655

Description	Contacts	Reference	Unit MRP [₹]
<b>Add On Blocks</b>			
Additional instantaneous auxiliary contact blocks	Side Mounted <sup>(1)</sup> 1NO + 1NC	LAD8N11	2815
	Side Mounted <sup>(1)</sup> 2NO	LAD8N20	2815
Pneumatic timer blocks front mounted	ON delay 1NO + 1NC 0.1..3s	LADT0	5315
	ON delay 1NO + 1NC 0.1..30s	LADT2	5315
	ON delay 1NO + 1NC 10..180s	LADT4	5315
	ON delay 1NO + 1NC 1..30s (2)	LADS2 ✓	5665
	OFF delay 1NO + 1NC 0.1 ..3s	LADR0	5315
	OFF delay 1NO + 1NC 0.1 ..30s	LADR2 ✓	5315
	OFF delay 1NO + 1NC 10..180s	LADR4	5315

(1) Suitable for mounting on TeSys Deca range AC Coil Contactors and Control Relays only

(2) With Switching time of 40 ms between opening of the NC contact and closing of the NO contact recommended for Star - Delta Starters

### Accessories compatibility

Contactors		Instantaneous Auxiliary Contacts				Time delay Front Mounted
Type	Number of Poles and Size	Side mounted	Front mounted			
			1 contact	2 contact	4 contacts	
AC & AC/DC	3P LC1D09...D38	1 on LH side	and -	1	or 1	or 1
AC & AC/DC	3P LC1D40A...D80A	1 on LH or 1 on RH side	and -	1	or 1	or 1
AC & AC/DC	3P LC1D80 and D95A (50/60 Hz)	1 on each side	or 2	and 1	or 1	or 1
AC & AC/DC	3P LC1D80 and D95A (50 or 60 Hz)	1 on each side	and 2	and 2	or 1	or 1
AC & AC/DC	3P LC1D115 and D150	1 on LH side	and -	1	or 1	or 1
AC & AC/DC	4P LC1DT20...DT40	1 on LH side	and -	1	or 1	or 1
AC & AC/DC	4P LC1DT60A and DT80A	1 on LH or 1 on RH side	and -	1	or 1	or 1
AC & AC/DC	4P LC1D40008, D65008 and D80	1 on each side	or 1	or 1	or 1	or 1
AC & AC/DC	4P LC1D115	1 on each side	and 1	or 1	or 1	or 1
DC	3P LC1D09...D38	-	-	1	or 1	or 1
DC	3P LC1D40A...D80A	-	-	1	or 1	or 1
DC	3P LC1D80 and D95	-	1	or 1	or 1	or 1
DC	3P LC1D115 and D150	1 on LH side	and -	1	or 1	or 1
DC	4P LC1DT20...DT40	-	-	1	or 1	or 1
DC	4P LC1DT60A and DT80A	-	-	1	or 1	or 1
DC	4P LC1D40008, D65008 and D80	-	2	and 1	or 1	or 1
DC	4P LC1D115	1 on each side	-	and 1	or 1	or 1
LC <sup>(3)</sup>	3P LC1D09...D38	-	-	1	-	-
LC <sup>(3)</sup>	3P LC1DT20...DT40	-	-	1	-	-

(3) LC : Low consumption

For details on non standard references, technical parameters, accessories, compatibility, stockable and non stockable status please contact Customer Care

✓ NORMAL STOCK ITEMS

W.E.F. January 15<sup>th</sup>, 2026

### Accessories

Description	For use with	Reference	Unit MRP [₹]
<b>For Contactor D115/150</b>			
Contacts set - 3P	LC1D115	LA5D1158031	32800
Contacts set - 3P	LC1D150	LA5D150803	34005
Contacts set - 4P	LC1D1150046	LA5D115804	45210

Product Compatibility	Fixing	Control Circuit Voltage	Suppressor Type	Reference	Unit MRP [₹]
<b>Coil Suppressor Modules</b>					
LC1D12...D25 (4P)	Screw	110...240V AC	RC Circuit AC	LA4DA1U	2570
	Screw	12...250V DC	Diode DC	LA4DC1U	2880
LC1D09...D38, LC2D09...D38, LC1DT20...DT40, LC2DT20...DT40 (3P)	Screw	24...48V AC	Varistor AC/DC	LAD4VE	2495
	Screw	24...48V AC 400Hz	RC Circuit AC	LAD4RCE	2495
CAD	Screw	50...127V AC 200Hz	RC Circuit AC	LAD4RCG	2250
	Screw	110...240V AC 100Hz	RC Circuit AC	LAD4RCU <input checked="" type="checkbox"/>	2495
LC1D80, LC1D95, LC2D80, LC2D95 (3P) LC2D80 (4P), LC1D40008, LC1D65008	Screw	110...250V AC	Varistor AC/DC	LAD4VU	2495
	Screw	24...250V DC	Diode DC	LA4DC3U	2570
	Screw	110...250V AC	Varistor AC/DC	LA4DE2U	2455
	Screw	24...48V AC 400Hz	RC Circuit AC	LA4DA2E	2455
	Screw	50...127V AC 200Hz	RC Circuit AC	LA4DA2G	3875
	Screw	110...240V AC 100Hz	RC Circuit AC	LA4DA2U	2570
	Screw	380...415V AC 150Hz	RC Circuit AC	LA4DA2N	3875
	Screw	24...48V DC	Varistor AC/DC	LA4DE3E	2570

For details on non standard references, technical parameters, accessories, compatibility, stockable and non stockable status please contact Customer Care

NORMAL STOCK ITEMS

W.E.F. January 15<sup>th</sup>, 2026

# TeSys Control

## TeSys Deca

### Accessories

## TeSys Deca auxiliary contact blocks for use in harsh industrial environment

Product references:  
coding principle

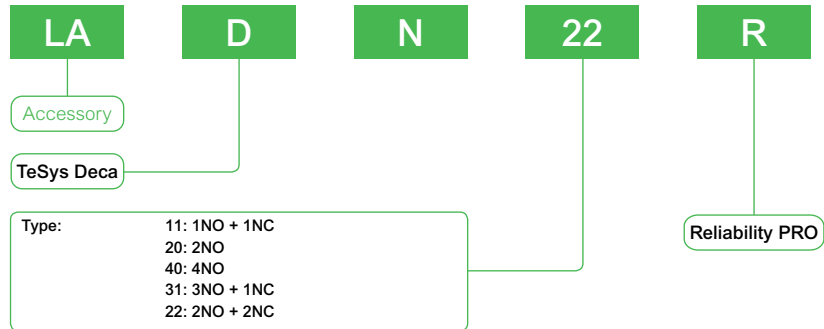

**Note:** There are differences in NO/NC position between LADN●●R and LADN●●. Please refer to page A1/42 for wiring diagram details. This auxiliary module only supports the installation on contactors with standard power consumption.

## Product core values

Dustproof, Ultra-fine grain silver contacts, Improved Reliability, 17 V/1 mA

### New upgrade, with innovative design



**20% stability increased on contacts**  
Improves contact reliability between mobile and static contacts



**Fully sealed design benefits on reduced dust access**  
Comprehensive blocking of dust and external pollution

**5X granularity refinement on silver alloy**  
Innovative binary alloy refinement process provides precise conduction for each operation

**10<sup>-8</sup> level on reliability**   
Capacity 17 V/1 mA

### Target industries and applications

- For elevator, textile machinery and other harsh industrial applications
- For low voltage and low current high sensitive applications

## Product variants:



LADN11R



LADN20R



LADN22R



LADN31R



LADN40R

LADN●●R for harsh environment 17 V/1 mA

Description	Reference	Unit MRP [₹]
Auxiliary module 1NO + 1NC, screw terminals	LADN11R	1190
Auxiliary module 2NO, screw terminals	LADN20R	1205
Auxiliary module 2NO + 2NC, screw terminals	LADN22R	1425
Auxiliary module 3NO + 1NC, screw terminals	LADN31R	1425
Auxiliary module 4NO, screw terminals	LADN40R	1440

For details on non standard references, technical parameters, accessories, compatibility, stockable and non stockable status please contact Customer Care

NORMAL STOCK ITEMS

W.E.F. January 15<sup>th</sup>, 2026

# TeSys Control

## TeSys Deca

Modular marking system simplifies identification of standard contactors in the control panel to enhance visibility of the safety chain

### Simple, customisable modular marking system

#### Standard TeSys Deca contactors

Easy-to-attach covers:



Auxiliary blocks with safety chain identification also available for more contact points:



Flexibility to customise contactors included in the safety chain during panel building



Simpler and faster maintenance with 100% visibility



Safety covers and auxiliary blocks prevent screwdriver contact with poles

#### Standard TeSys Ultra motor starters

Translucent labels to identify safety-chain devices:



### Complete safety-chain identification system

#### TeSys Deca range

Retrofit contactor safety covers



LAD9ET1S  
9A upto 65A



LAD9ET3S  
80A to 95A



LAD9ET4S  
110A to 150A



LADN22S  
2NO + 2NC

Also available for CAD32/CAD50

#### TeSys Ultra range

Retrofit identification label



LU9ET1S

### Built in Safety

TeSys Ultra motor starters are certified according to IEC 60947-4-1 for safety applications thanks to integrated mirror contact

Description	For use with	Reference	Unit MRP [₹]
Red Cover (For safety chain indication)	LC1D09...D65A and DT20 .. DT80A	LAD9ET1S	1055
Auxiliary Contact block with red front face- for safety chain indication	2NO + 2NC	LADN22S	1510

For details on non standard references, technical parameters, accessories, compatibility, stockable and non stockable status please contact Customer Care

NORMAL STOCK ITEMS

W.E.F. January 15<sup>th</sup>, 2026



# TeSys Giga - Future Ready

## A New Generation Series with Digital Innovation

TeSys Giga is new range of high-power contactors that supports industry requirements with process performance monitoring through data networks and online expert services.

### Optimized Predictive Maintenance through-

- Continuous local and remote monitoring of contact wear
- Replaceable contacts (when necessary), facilitated by diagnostic visual indicator.

### Unique Design-

- Innovative design and feature with compact size
- Ergonomic design & Flexibility in connections.
- Embedded auxiliary contact blocks
- Wideband electronic coils



# TeSys Control

## TeSys Giga

### TeSys Giga High Power Contactors

Both "Standard" & "Advanced" versions available in 3 sizes, covering several ratings



#### Standard Version

##### Power & control

- 3 or 4 power poles
- 115 to 800A (AC-3)
- 200 to 1050A (AC-1)
- Embedded 1 NO + 1 NC auxiliary contacts
- Push-in type terminals for coils & control

##### Remote control

- 48-130V, 100-250V AC/DC coils
- Wide voltage range coils (direct coil control)
- Embedded surge-suppressor

##### Diagnostic

- Embedded wear diagnostic
- Embedded control voltages diagnostic
- Self diagnosis function
- Local alarm signaling (LED)



#### Advanced Version

##### Advanced diagnostic features along with standard version -

##### Diagnostic

- Remote wear diagnostic signaling kit (accessory)

##### Mounting

- Cable memory' adapter enables maintenance without removing power cables and busbar connections.

##### Remote control

- 24-48 V, 200-500 V AC/DC coils
- Digital control input (PLC output digital coil control)



Interlock location, with knock-out cover

On/Off switch for PLC input

Push-in type control terminals enabling quick wiring and assembly

Diagnosis LED for contact wear & voltage abnormality

Built-in 1 NO + 1 NC auxiliary contact block

Unique QR code providing quick access to complete product data

Mechanical indicator for contactor open and closed status

# TeSys Control

## TeSys Giga

### Quick & Easy Replacement of 3P TeSys F with TeSys Giga Contactors with Retrofit Bases



Description	Reference	Unit MRP [₹]
Substitutes LC1F115-225 with LC1G115-225	LA9GRFB1	7255
Substitutes LC1F265-500 with LC1G265-500	LA9GRFB2	8310
Substitutes LC1F630-800 with LC1G630-800	LA9GRFB3	16065



- Suitable for **3 pole contactors only**
- The bases come in two frame sizes.
- Upgrade your system with the new range of contactors in just 3 simple steps:

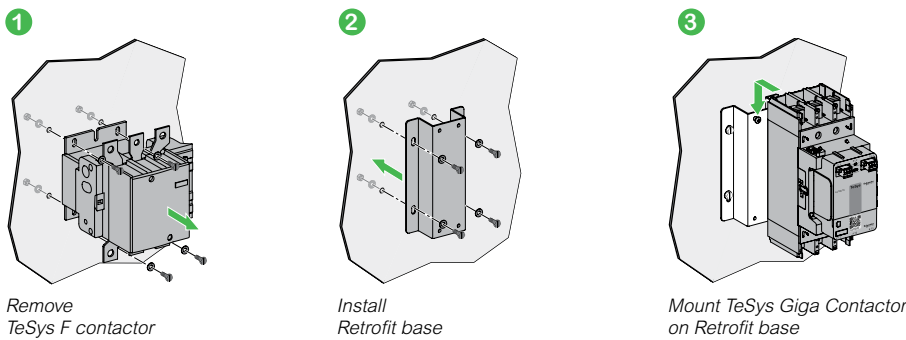

### TeSys Giga Power Contactors (3 Pole AC/DC)

[Ie] Rated Operational Current AC-1	Motor Power (Long Life) AC-3		Standard version Reference	Unit MRP [₹]	
	kW (@415V)	A		EHEN (48-130 V)	KUEN (100-250 V)
250	55	115	LC1G115****	38370	39685
275	75	150	LC1G150****	50610	50610
305	90	185	LC1G185****	62720	62720
330	110	225	LC1G225****	67490	67490
385	132	265	LC1G265****	82955	82955
440	160	330	LC1G330****	100310	100310
550	200	400	LC1G400****	121235	121235
700	250	500	LC1G500****	168185	168185
1050	375	630	LC1G630****	259725	259725
1050	450	800	LC1G800****	315495	315495

### TeSys Giga Power Contactors (4 Pole AC/DC)

[Ie] Rated Operational Current AC-1	Power Pole Composition	Standard version Reference	Unit MRP [₹]	
			EHEN (48-130 V)	KUEN (100-250 V)
250	4 NO	LC1G1154****	65275	65275
275	4 NO	LC1G1504****	77665	77665
305	4 NO	LC1G1854****	97045	97045
330	4 NO	LC1G2254****	113995	113995
385	4 NO	LC1G2654****	127450	127450
440	4 NO	LC1G3304****	148320	148320
550	4 NO	LC1G4004****	184330	184330
700	4 NO	LC1G5004****	271650	271650
1050	4 NO	LC1G6304****	312390	312390
1050	4 NO	LC1G8004****	374860	374860

**Note:**

For ordering advanced version replace **N** with **A** in reference as EHEN/KUEN → EHEA/KUEA respectively.

Example: LC1G1154 EHEN → LC1G1154 EHEA.

For other coil voltage ratings contactors, please contact Customer Care.

\* Reference to be completed by adding coil voltage code

For details on non standard references, technical parameters, accessories, compatibility, stockable and non stockable status please contact Customer Care

☑ NORMAL STOCK ITEMS

W.E.F. January 15<sup>th</sup>, 2026

# TeSys Control

## TeSys Giga

### Giga High power contactors – Power wiring accessories

#### Product references

#### Power Terminals

##### Spreader Kits



Description	Suitable for	Compatible with Contactors	Increase of Pole Pitch	Quantity Set of	Reference	Unit MRP [₹]
Spreader kits	3P	LC1G115...LC1G225	35 to 45 mm	3	LA9G3611	6855
	3P	LC1G265...LC1G500	45 to 70 mm	3	LA9G3612	6855
	4P	LC1G115...LC1G225	35 to 45 mm	4	LA9G4611	8570
	4P	LC1G265...LC1G500	45 to 70 mm	4	LA9G4612	8570

#### Terminal extensions for larger power connections



Description	Suitable for	Compatible with Contactors	Power Connection Size	Quantity Set of	Reference	Unit MRP [₹]
Terminal connections	3P	LC1G400...LC1G500	50 mm width	3	LA9G3613	8570
	3P	LC1G630...LC1G800	80 mm width	3	LA9G3614	45700
	4P	LC1G400...LC1G500	50 mm width	4	LA9G4613	10280
	4P	LC1G630...LC1G800	80 mm width	4	LA9G4614	67005

#### Power Terminal Accessories

##### Phase Separators



Description	Suitable for	Compatible with Contactors	Quantity Set of	Reference	Unit MRP [₹]
Phase separators <sup>(1)</sup>	3P	LC1G115...LC1G800	2	LA9G3801	1710
	4P	LC1G115...LC1G800	3	LA9G4801	2140
	3P – with 50/80 mm spreaders	LC1G400...LC1G800	2	LA9G3803 <sup>(2)</sup>	1725
	4P – with 50/80 mm spreaders	LC1G400...LC1G800	3	LA9G4803 <sup>(3)</sup>	2140

(1) Either phase separators or terminal shrouds can only be mounted. Phase separators or terminal shrouds are mandatory for operational voltage,  $U_e \geq 690$  V.

(2) To be used with LA9G3613 and LA9G3614.

(3) To be used with LA9G4613 and LA9G4614.

For details on non standard references, technical parameters, accessories, compatibility, stockable and non stockable status please contact Customer Care

NORMAL STOCK ITEMS

W.E.F. January 15<sup>th</sup>, 2026

# TeSys Control

## TeSys Giga

### Accessories

Description	Terminal Type	Position	Contacts	Reference	Unit MRP [₹]
<b>Add On Blocks</b>	<b>Push In</b>				
	1st left or 1st right	Side Mounted <sup>(1)</sup>	1 NO+1NC	LAG8N113P	1840
Auxiliary contact module	1st left or 1st right	Side Mounted	2 NO	LAG8N203P	2375
	2nd left or right	Side Mounted	1 NO+1NC	LAG8N113	1840
	2nd left or right	Side Mounted	2 NO	LAG8N203	2375

(1) Always supplied with TeSys Giga LC1G contactors, fitted to the right side lateral face.

### Accessories

For Use With Contactor	Reference	Unit MRP [₹]
<b>Mechanical interlock between contactors <sup>(1)</sup></b>		
Between Identical contactor frames	LA9G970	3340
Between LC1G(265-500) and LC1G(185-225)	LA9G971	3340
LC1G630 to LC1G800 and LC1G265 to LC1G500	LA9G972	On Request*

(1) Maximum 3 auxiliary contacts can be installed between 2 contactors with mechanical interlock kit.

### Spare Control Module



- Wide band electronic control
- 24 V...500 V 50/60 Hz or DC control input
- Advanced and standard versions
- Accessible from the front for easy and quick replacement

Pole Composition	Control modules for Standard contactors	Reference	Unit MRP [₹]	
			EHEN (48-130V)	KUEN (100-250V)
3-Pole	LC1G115...LC1G225	LX1G3Q*	On Request	On Request
3-Pole	LC1G265...LC1G330	LX1G3R*	On Request	On Request
3-Pole	LC1G400...LC1G500	LX1G3S*	On Request	On Request
3-Pole	LC1G630...LC1G800	LX1G3T*	On Request	On Request
4-Pole	LC1G115...LC1G225	LX1G3Q*	On Request	On Request
4-Pole	LC1G265...LC1G330	LX1G3R*	On Request	On Request
4-Pole	LC1G400...LC1G500	LX1G3S*	On Request	On Request
4-Pole	LC1G630...LC1G800	LX1G3T*	On Request	On Request

For other coil voltage ratings regarding above, please contact Schneider Electric customer care.

\* Reference to be completed by adding coil voltage code

For details on non standard references, technical parameters, accessories, compatibility, stockable and non stockable status please contact Customer Care







NORMAL STOCK ITEMS

W.E.F. January 15<sup>th</sup>, 2026

# TeSys Protection Range

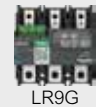
TeSys has the most rugged and reliable solution to manage motors

Please find a quick range overview below

	TeSys Power	TeSys Protect			TeSys Active		
Feature	Motor Protection Circuit Breakers	Overload Relays	Multi function Relays		TeSys Ultra	TeSys Tera	TeSys Island
TeSys Range of Products	GV2P, GV4P GV3P, GV2ME	LR2K, LRD, LR9D, LR9F	LR9G	EOCR			
	 GV2P GV3P GV2ME	 LR2K LR9D LRD LR9F	 LR9G	 EOCR	 TeSys Ultra	 TeSys Tera	 TeSys Island
Short circuit							
Causes of overheating							
Slight overload							
Locked rotor							
Ventilation fault With probes							With Probes
Abnormal temperature rise							With Probes
Shaft bearing seizure							
Insulation fault				With CBCT			
Long starting time Adjustable				Adjustable	Adjustable		Adjustable
Heavy duty		LR9D only					
Voltage variation (Derived)							
Causes of phase variation							
Phase reversal							
Phase losses							
Phase imbalance							
Earth fault							
Historic fault, Pre-Alarming			Possible Pre alarm				



# Protection Relays for Motor Safety

Providing motor safety tailored to your needs



# TeSys Protect

## TeSys K, TeSys Deca, TeSys F, TeSys Giga

### Thermal Overload Relays - TeSys K Series (Direct Mounting)



- Conformance to IEC, UL, CSA, CE
- Range : 0.1A to 16A
- Direct & Independent mounting
- Trip class 10A

Thermal Protection Adjustment	For Use With	For Use With	Unit MRP [₹]
0.11...0.16		LR2K0301	3275
0.16...0.23		LR2K0302	3275
0.23...0.36		LR2K0303	3275
0.36...0.54		LR2K0304	3275
0.54...0.8		LR2K0305	3275
0.8...1.2		LR2K0306	3275
1.2...1.8	LC1K, LP1K, LP4K, LP2K, LC2K	LR2K0307	3275
1.8...2.6		LR2K0308	3275
2.6...3.7		LR2K0310	3275
3.7...5.5		LR2K0312	3275
5.5...8		LR2K0314	3275
8...11.5		LR2K0316	3275
10...14		LR2K0321	3390
12...16		LR2K0322	3390

\*Note: Terminal Block for Clip-on Mounting LA7K0064

### Thermal Overload Relays - TeSys Deca Series



- Conformance to IEC, UL, CSA
- Range : 0.1A to 104A
- Higher operating temperature
- Tripping class 10A & 20 available
- Direct mounting on contactor is possible upto 95A

Thermal Protection Adjustment Range	For Use With	Reference*	Unit MRP [₹]
<b>LRD Model (Direct Mounting)</b>			
0.1...0.16		LRD01	3285
0.16...0.25		LRD02	3285
0.25...0.4		LRD03	3285
0.4...0.63		LRD04	3285
0.63...1		LRD05 ✓	3285
1...1.6	GV2L03, LE03, LC1D09...LC1D38	LRD06 ✓	3285
1.6...2.5		LRD07 ✓	3285
2.5...4		LRD08 ✓	3285
4...6		LRD10 ✓	3285
5.5...8		LRD12 ✓	3285
7...10		LRD14 ✓	3685
9...13		LRD16 ✓	3685
12...18		LRD21 ✓	3795
16...24	GV2L22, LC1D25...D38	LRD22 ✓	3800
23...32	LC1D25...LC1D38, LC1D32	LRD32 ✓	6100
30...38	LC1D32, LC1D38	LRD35	6100
23...32	LC1D40A...D65a	LRD332	6760
23...32	LC1D80...LC1D95	LRD3353	6760
30...40	LC1D40A...D65a	LRD340	6760
30...40	LC1D80...LC1D95	LRD3355	6760
37...50	LC1D40A...D65a	LRD350 ✓	9265
37...50	LC1D80...LC1D95	LRD3357	11080
48...65	LC1D40A...D65a	LRD365	11885
62...80	LC1D80A	LRD380	12400
48...65	LC1D80...LC1D95	LRD3359	11885
63...80	LC1D80...LC1D95	LRD3363	12900
80...104	LC1D80, LC1D95	LRD3365	15925

### Electronic Overload Relay - TeSys Deca Series

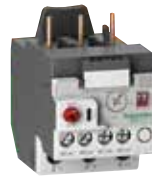

- Conformance to IEC, UL, CSA
- Range : 0.1A to 32A
- 5:1 Adjustment range
- High Operating Temperature
- Field selectable tripping class : 5,10, 20 & 30
- Type 1 & Type 2 Co-ordination chart available

Current Range	For Use With	Reference*	Unit MRP [₹]
0.1...0.5		LR9D01	14905
0.4...2.0	LC1D09 - 38A Direct Mounting	LR9D02	15300
1.6...8.0		LR9D08	15300
6.4...32		LR9D32	17125

\*Note: For LR9D01 to LR9D32 - Terminal Block for Clip on Mounting LAD7B205.

### Electronic Overload Relay - TeSys Giga Series



- Wide range of protection with only 4 references (28A to 630A)
- Switchable protection against ground fault and phase imbalance
- ON status and overload alarm signaling by LED
- Direct mounting of relay with contactors saving in panel space and installation time
- Selectable Trip class from 5E to class 30E to suit different application needs

Thermal Protection Adjustment Range	Reference	Unit MRP [₹]
28...115 A	LR9G115	26570
57...225 A	LR9G225	31000
125...500 A	LR9G500	36460
160...630 A	LR9G630*	on request

### Separate Components for Relays

Description	For Use With	Reference	Unit MRP [₹]
Terminal block for clip-on mounting on 35 mm DIN Rail or screw fixing; for fixing centres	LRD01...35 & LR3D02...D35	LAD7B106	1555
	LRD33●●, LR3D33●●, LR2D35●●, LR3D35●●	LA7D3064	4910
EverLink® terminal block for independent mounting	LRD3●●, LRD3●●L & LR3D3●●	LAD96560	4130

\*Note:

- The LRD relays can be used for AC or DC current up to 104A
- For long starting, Class 20 relays are available on request.
- Device for remote tripping and electrical reset is available on request.

For details on non standard references, technical parameters, accessories, compatibility, stockable and non stockable status please contact Customer Care

✓ NORMAL STOCK ITEMS

W.E.F. January 15<sup>th</sup>, 2026



- Reduced downtime
- Quick restoration
- Operational Safety
- Power Quality management



## Electronic Overcurrent Relays

### Digital EOCR

#### Protection

- Over Current-Definite & Inverse Time
- Under Current
- Phase Loss
- Phase Reversal
- Stall
- Jam
- Imbalance
- Earth Fault\*

#### Diagnostic

- Trip Cause
- Fault History-3 Faults (Cause & Current Value)

#### Measurement

- Load Current
- Ground Current\*
- Running Hours
- Load Current Bar Graph
- i-THD (Current Harmonic Distortion)

#### Other Features

- Modbus Communication\*
- 4-20 mA output for Motor Current\*
- Pre-Alarm Contact
- Suitable for 1 $\Phi$  & 3 $\Phi$  Motors
- Suitable for Low Frequency VFD Operation (10-100Hz)
- Available with Type-2

### Analog EOCR

#### Protection

- Over current
- Phase loss
- Locked rotor

#### Other Features

- Easy installation, with DIN Rail and Panel Mounting compatibility
- Trip cause display
- Manual/Electrical reset
- Testing Provision through Test Button
- Suitable for 1 $\Phi$  & 3 $\Phi$  Motors

\* In selected models

[se.com/in](http://se.com/in)

# TeSys Protect EOCR

## Digital EOCR





Digital EOCR Without Communication Current Range=0.5A-80A Control Voltage=100VAC-220VAC*					
Description	Display	Bottom Hole		Window Hole	
		Reference	Unit MRP [₹]	Reference	Unit MRP [₹]
Without Ground Fault Protection	Inbuilt	3DM2-WRDUHZ	28205	3DM2-WRDUWZ	28205
	Extended**	FDM2-WRDUHZ	30500	FDM2-WRDUWZ	30500
GF Protection with external CT	Inbuilt	3MZ2-WRAUHZ	28580	3MZ2-WRAUWZ	28580
	Inbuilt	3MZ2-WRCUHZ	28580	3MZ2-WRCUWZ	28580
	Extended**	FMZ2-WRAUHZ	34320	FMZ2-WRAUWZ	34320
	Extended**	FMZ2-WRCUHZ	34320	FMZ2-WRCUWZ	34320
GF Protection with inbuilt CT	Inbuilt	3BZ2-WRAUHZ	41495		
	Inbuilt	3BZ2-WRCUHZ	41495		
	Extended**	FBZ2-WRAUHZ	42160		
	Extended**	FBZ2-WRCUHZ	42160		

Digital EOCR with Modbus Communication Current Range=0.5A-80A Control Voltage=100VAC-220VAC*					
Description	Display	Bottom Hole		Window Hole	
		Reference	Unit MRP [₹]	Reference	Unit MRP [₹]
Without Ground Fault Protection	Inbuilt	I3DM-WRDUHZ	45315	I3DM-WRDUWZ	45315
	Extended**	IFDM-WRDUHZ	45610	IFDM-WRDUWZ	45610
GF Protection with external CT	Inbuilt	I3MZ-WRAUHZ	48190	I3MZ-WRAUWZ	48190
	Inbuilt	I3MZ-WRCUHZ	48190	I3MZ-WRCUWZ	48190
	Extended**	IFMZ-WRAUHZ	54585	IFMZ-WRAUWZ	54585
	Extended**	IFMZ-WRCUHZ	54585	IFMZ-WRCUWZ	54585
GF Protection with inbuilt CT	Inbuilt	I3BZ-WRAUHZ	55840		
	Inbuilt	I3BZ-WRCUHZ	55840		
	Extended**	IFBZ-WRAUHZ	56130		
	Extended**	IFBZ-WRCUHZ	56130		

\* Replace **U** with **B** in above reference for Control Voltage =24 V DC  
 \*\* Cable need to be purchased separately  
 Contact Customer Care for 4-20mA Output EOCR references & prices

## EOCR Accessories

Cable for Extended Display			
Description	Reference	Unit MRP [₹]	
 CABLE-RJ45 1 Meter	CABLE-RJ45-001	3285	
CABLE-RJ45 3 Meter	CABLE-RJ45-003	4290	

ZCT - Ground Fault Protection		
Description	Reference	Unit MRP [₹]
 ZCT 35 M/M	ZCT-035-Z	9020
ZCT 80 M/M	ZCT-080-Z	12150
ZCT 120 M/M	ZCT-120-Z	19985

External CT for range extension up to 400A				
Current Range	CT Ratio	Reference	Unit MRP [₹]	
 100A	100:5	3CT-H1-100-Z	7180	
150A	150:5	3CT-HH-150-Z	8890	
200A	200:5	3CT-H2-200-Z	9900	
300A	300:5	3CT-H3-300-Z	10330	
400A	400:5	3CT-H4-400-Z	12150	

Spare Display		
Description	Reference	Unit MRP [₹]
EOCR-PDMZ Display	EOCR-PDMZ	12890

For details on non standard references, technical parameters, accessories, compatibility, stockable and non stockable status please contact Customer Care

NORMAL STOCK ITEMS

W.E.F. January 15<sup>th</sup>, 2026

# TeSys Protect

## Analog EOCR

### EOCR SS

- Without Display



Analog EOCR without Display			
Current Range (A)	Control Voltage	Reference	Unit MRP [₹]
0.5-6	24-240V AC/DC	EOCRSS-05S	8940
0.5-6	380-440V AC	EOCRSS-05W	7320
3-30	24-240V AC/DC	EOCRSS-30S	8940
3-30	380-440V AC	EOCRSS-30W	7320
5-60	24-240V AC/DC	EOCRSS-60S	8940
5-60	380-440V AC	EOCRSS-60W	7320

**Note:** 2 SPST output contacts  
For 60A or higher, combine 05T Type and an external CT (secondary 5A) for use

### EOCR SSD

- With Display (Operating Current & Trip Cause)



Analog EOCR with Display			
Current Range (A)	Control Voltage	Reference	Unit MRP [₹]
0.5-6	24-240V AC/DC	EOCRSSD-05S	13370
0.5-6	380-440V AC	EOCRSSD-05W	16465
3-30	24-240V AC/DC	EOCRSSD-30S	13370
3-30	380-440V AC	EOCRSSD-30W	14270
10-60	24-240V AC/DC	EOCRSSD-60S	13370
10-60	380-440V AC	EOCRSSD-60W	14270

**Note:** 2 SPST output contacts  
For 60A or higher, combine 05T Type and an external CT (secondary 5A) for use

For details on non standard references, technical parameters, accessories, compatibility, stockable and non stockable status please contact Customer Care

NORMAL STOCK ITEMS

W.E.F. January 15<sup>th</sup>, 2026



# TeSys Power

Circuit breakers for motor protection and control

TeSys Deca and TeSys Giga Circuit Breakers provide compact, reliable and efficient solutions:

- Isolation
- Protection against short circuits and overloads
- Conforming to global standards.(IEC/EN/UL/CSA)



[se.com/in/TeSys](https://se.com/in/TeSys)

# TeSys Power

## Circuit Breakers for Motor Protection

### Magnetic Circuit Breaker



- Conformance to IEC 60947 -1,-2,-4
- Magnetic circuit breakers range from 0.1-80 Amps
- High Breaking capacity up to 100kA
- Wide range of accessories

Breaking Capacity at 50Hz		Magnetic Protection Rating (A)	Reference	Unit MRP [₹]
690V	500V			

#### With Rocker Lever Control (Economy)\*

Breaking Capacity at 50Hz	Motor Power AC-3**	Magnetic Protection Rating (A)	Reference	Unit MRP [₹]
100 kA	100 kA	0.4	GV2LE03	7035
		0.63	GV2LE04	7035
		1	GV2LE05	7035
		1.6	GV2LE06	7035
3 kA	100 kA	2.5	GV2LE07	7035
		4	GV2LE08	7035
3 kA	50 kA	6.3	GV2LE10	7035
	10 kA	10	GV2LE14	7035
3 kA	6 kA	14	GV2LE16	7035
		18	GV2LE20	8170
		25	GV2LE22	8170
3 kA	4 kA	32	GV2LE32	13880

#### With Rotary Handle Control\*

Breaking Capacity at 50Hz	Motor Power AC-3**	Magnetic Protection Rating (A)	Reference	Unit MRP [₹]
100 kA	100 kA	0.4	GV2L03	8075
		0.63	GV2L04	8075
		1	GV2L05	8075
4 kA	100 kA	1.6	GV2L06	8075
		2.5	GV2L07	8075
		4	GV2L08	8075
		6.3	GV2L10	8075
		10	GV2L14	8075
4 kA	10 kA	14	GV2L16	8075
		18	GV2L20	8075
		25	GV2L22	8075
		32	GV2L32	8075
		40	GV3L40	22880
6 kA	12 kA	50	GV3L50	23420
		65	GV3L65	23930
		73	GV3L73	27055

Breaking Capacity at 415V 50Hz	Motor Power AC-3**	Thermal Protection Adjustment Range	Reference	Unit MRP [₹]
	kW	HP		

#### With Toggle Control

50 kA	75	101	150	C16N3MA150	On Request
	110	147	220	C25N3MA220	On Request
	160	214	320	C40N31M320	On Request
	200	268	500	C63N31M500	On Request

### Thermal Magnetic Circuit Breaker



- Conformance to IEC 60947 -1,-2,-4, conformity to International Standards - UL, CSA, CE
- Thermal magnetic circuit breakers range from 0.1-220 Amps
- High Breaking capacity up to 100kA
- Wide range of accessories
- S-shaped busbar for side-by-side connection with 40 - 65A Contactor

Breaking Capacity at 50Hz		Thermal Protection Adjustment Range	Reference	Unit MRP [₹]
690V	500V			

#### With Push Button Control (Economy)

Breaking Capacity at 50Hz	Motor Power AC-3**	Thermal Protection Adjustment Range	Reference	Unit MRP [₹]
100 kA	100 kA	0.1 - 0.16	GV2ME01	7365
		0.16 - 0.25	GV2ME02	7365
		0.25 - 0.40	GV2ME03	7365
		0.40 - 0.63	GV2ME04	7845
		0.63 - 1.0	GV2ME05	7845
3 kA	100 kA	1.0 - 1.6	GV2ME06	8015
		1.6 - 2.5	GV2ME07	8015
		2.5 - 4	GV2ME08	8295
3 kA	50 kA	4 - 6.3	GV2ME10	8295
	10 kA	6 - 10	GV2ME14	8295
3 kA	6 kA	9 - 14	GV2ME16	9290
		13 - 18	GV2ME20	10005
		17 - 23	GV2ME21	10680
3 kA	4 kA	20 - 25	GV2ME22	10680
		24 - 32	GV2ME32	17300

#### With Rotary Handle Control

Breaking Capacity at 50Hz	Motor Power AC-3**	Thermal Protection Adjustment Range	Reference	Unit MRP [₹]	
100 kA	100 kA	0.1 - 0.16	GV2P01	7145	
		0.16 - 0.25	GV2P02	7145	
		0.25 - 0.40	GV2P03	7145	
		0.40 - 0.63	GV2P04	8190	
		0.63 - 1.0	GV2P05	8190	
8 kA	100 kA	1.0 - 1.6	GV2P06	8190	
		1.6 - 2.5	GV2P07	8190	
6 kA	100 kA	2.5 - 4	GV2P08	8445	
	50 kA	4 - 6.3	GV2P10	8445	
4 kA	10 kA	6 - 10	GV2P14	9015	
		42 kA	9 - 14	GV2P16	11065
		13 - 18	GV2P20	12770	
		17 - 23	GV2P21	12770	
		20 - 25	GV2P22	12770	
6 kA	12 kA	24 - 32	GV2P32	21530	
		30...40	GV3P40	25400	
		37...50	GV3P50	31490	
6 kA	12 kA	48...65	GV3P65	32300	
		62...73	GV3P73	33010	

#### With Rotary Handle Control

10 kA	50 kA	70...150	GV5P150H	59655
		100...220	GV5P220H	69585
		160...320	GV6P320H	89485
		250...500	GV6P500H	123290

#### With Direct Rotary Handle

10 kA	50 kA	70...150	GV5P150H	59655
		100...220	GV5P220H	69585
		160...320	GV6P320H	89485
		250...500	GV6P500H	123290

It is recommended to check with Customer care team for selection, recommendation, and availability of stockable and non stockable references

☑ NORMAL STOCK ITEMS

W.E.F. January 15<sup>th</sup>, 2026



## TeSys Power Motor Protection Solutions with Fast and Reliable SNAP IN Connections up to 15 kW



Spring-type terminals are now upgraded to **SNAP IN** connections  
- delivering a more robust, reliable, and user-friendly solution!



It's so **QUICK** as one second

- Up to 92% time saving compared with other connection technology

### TeSys Deca Motor Circuit Breakers SNAP IN Type

**GV2ME**

Range

**01**

AC-3/AC-3e Rating

01 : 0.1-0.16 amp	10 : 4-6.3 amp
02 : 0.16-0.25 amp	14 : 6-10 amp
03 : 0.25-0.40 amp	16 : 9-14 amp
04 : 0.40-0.63 amp	20 : 13-18 amp
05 : 0.63-1 amp	21 : 17-23 amp
06 : 1-1.6 amp	22 : 20-25 amp
07 : 1.6-2.5 amp	32 : 24-32 amp
08 : 2.5-4 amp	

**A**

Main Terminal

3: Spring

↓  
Getting Replaced with

**A: SNAP IN** **NEW**

For price details, please contact the respective sales representative.

# Simplicity with just 1 click for 1 second

It's so **EASY** as one hole, one pusher, one click.

- No special tool skills needed.
- No wiring tool needed regardless of flexible, solid or fine-stranded conductors



## Simplicity It's so QUICK!

- Electrical connection under one second
- Up to 92% faster than traditional technologies

## Scalability READY-TO-ROBOT!

- The first motor circuit breaker suitable for fully automatic mounting and wiring.

## Scalability Comprehensive solution!

- Up to 15 kW motor protection solution thanks to extensive accessories

## Simplicity It's so EASY!

- The world's first self-explanatory clamping technology. One hole, one pusher, one click.
- Solid and flexible wires with or without cable end can be connected without any tools.

## Reliability It's so SECURE!

- Your peace of mind with every connection through, a clearly audible click and the pusher moves forwards.

## Reliability General benefits

- Each connection has a testing point for diagnostics
- Maintenance-free clamping technology
- One-handed unwiring



NEW



# Reliability from install to maintain

## It's so SECURE

- Clear indication by a sound and visual feedback as confirmation to the electricians

 <p><b>Delivery status</b></p>	 <p><b>Wiring</b></p>	 <p><b>Clamping</b></p>
<p>The device is supplied with a preloaded spring. The switching status of the preloaded terminal point is indicated by the position of the pusher.</p>	<p>The stripped wire can be easily and securely inserted into the terminal point without any further preparation.</p>	<p>When the wire touches the ground contact of the terminal, the spring of the clamping point is released and shoots the terminal. This changes the position of the pusher and a clear 'click' can be heard.</p>

## Reliability benefits the whole customer journey

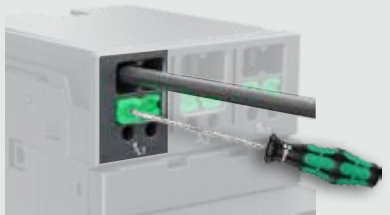
<p><b>Testing</b></p>	<p><b>Operation</b></p>	<p><b>Maintenance</b></p>
<p>Measuring point of each connection</p>	<p>Maintenance-free clamping technology</p>	<p>One-handed unwiring</p>
<p>Ideal for final acceptance tests as well as maintenance &amp; service</p> 	<p>Robust against vibrations and shocks</p> 	<p>First reset all pushers. Then all wires can then be removed without using any force.</p> 

# TeSys Power

## Circuit Breakers for Motor Protection

### Accessories for Motor Circuit Breakers

Description	Reference	Unit MRP [₹]	
<b>For GV2</b>			
Front contact NO or NC <sup>(1)</sup>	GVAE1	1585	
Front contact NO + NC	GVAE11 <input checked="" type="checkbox"/>	1930	
	GVAE20	2135	
Side contact NO + NC	GVAN11 <input checked="" type="checkbox"/>	2330	
	GVAN20	2330	
Fault signalling contact + 1NO contact <sup>(2)</sup>	GVAD1010 <input checked="" type="checkbox"/>	3040	
Fault signalling contact + 1NC contact <sup>(2)</sup>	GVAD1001	3040	
Short circuit signalling contact block 1 C/O	GVAM11	2905	
Under voltage trip	110 ... 115V 50Hz	GVAU115	6170
	220 ... 240V 50Hz	GVAU225	5550
	380 ... 400V 50Hz	GVAU385	5550
Shunt trip	110 ... 115V 50Hz	GVAS115	5550
	220 ... 240V 50Hz	GVAS225	5550
	380 ... 400V 50Hz	GVAS385	5550
Additive limiter for increasing breaking capacity to 100kA for GV2ME and GV2P.	GV1L3	8950	
Connection block - GV2 with contactor LC1-D09..D38	GV2AF3	1085	
Connection block - LS1 D32 or GV2 with Contactor LC1-K or LP1-K	GV2AF01	1175	
Empty enclosure for GV2ME - plastic	GV2MP02	5205	
	GV2MC02	5715	

(1) Choice of NC or NO contact operation depending on which way round the reversible block is mounted.

(2) The GV-AD is always mounted next to the circuit breaker.

### Busbars

Connection Pitch	No. of Tapoff Points	Reference	Unit MRP [₹]
<b>For GV2</b>			
45 mm	2	GV2G245	3065
	4	GV2G445	4820
54 mm	2	GV2G254	2780
	3	GV2G354	3115
	4	GV2G454	3905
72 mm	5	GV2G554	4230
	4	GV2G472	4785

Description	Reference	Unit MRP [₹]
<b>Accessories for Busbars</b>		
Terminal block - to supply one or more 3-pole busbar GV2	GV2G05	5995
Protective end covers for unused busbar outlets	GV1G10	1055
Terminal block for connection from top	GV1G09	3130

### Accessories for Motor Circuit Breakers

Description	Reference	Unit MRP [₹]
<b>For GV2-P/GV2-L</b>		
External operator - IP54, Black	GV2APN01 <input checked="" type="checkbox"/>	5505
External operator - IP54, Yellow/Red	GV2APN02	10250
<b>For GV3P/GV3L</b>		
<b>Auxiliary Contacts</b>		
Front contact: 1 NO (fault) + 1NC (Auxiliary)	GVAED011	2005
Front contact: 1 NO (fault) + 1NO (Auxiliary)	GVAED101	2205
<b>Busbar</b>		
3-pole, 3 tap, 64 mm pitch	GV3G364	3036
S-shape bus bar	GV3S	2205
<b>External Operator</b>		
IP54, Black	GV3APN01	6635

**Note:** All other accessories are same as of GV2.

Busbars GV3G364 and GV3S are not compatible with GV3\*73 and GV3\*80.

Description	Operating Voltage	Reference	Unit MRP [₹]
<b>For GV5 and GV6</b>			
Clip-on connector - upto 150 A - 1.5..95 mm <sup>2</sup>	-	GV7AC021	1925
Clip-on connector- upto 220 A - 1.5..185 mm <sup>2</sup>	-	GV7AC022	2650
Front rotary handle GV7AP GV7R - black handle <sup>(2)</sup>	-	GV7AP01	13950
Terminal shields IP405 <sup>(1)</sup>	-	GV7AC01	4960

(1) Terminal shields cannot be used together with spreaders.

(2) For mounting direct rotary handle on enclosure door.

This accessory makes it possible to open the door if the device is closed and prevents the device from being closed if the door is open.

It is recommended to check with Customer care team for selection, recommendation, and availability of stockable and non stockable references

NORMAL STOCK ITEMS

W.E.F. January 15<sup>th</sup>, 2026

# TeSys

## Accessories compatibility

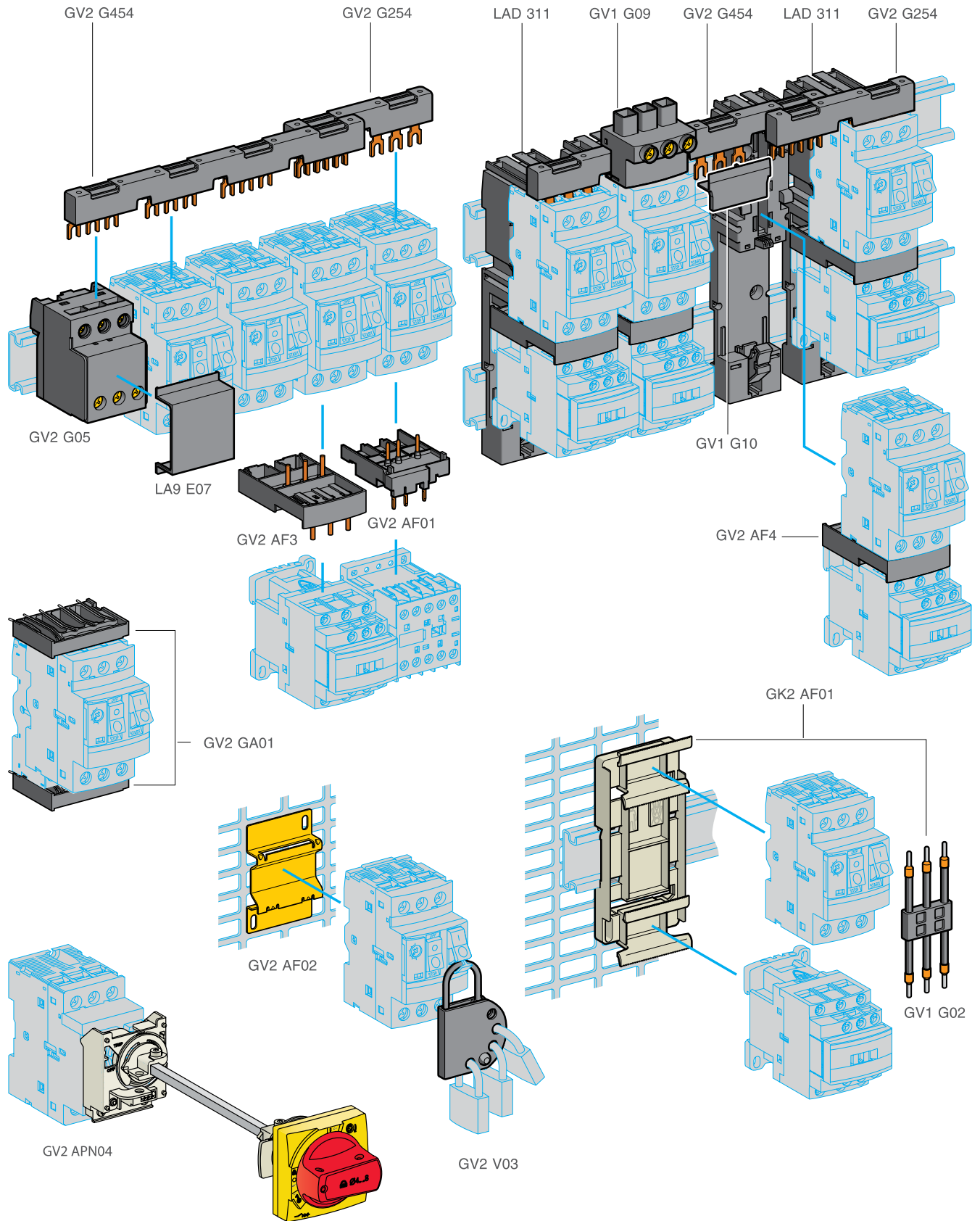

# TeSys

## Accessories compatibility

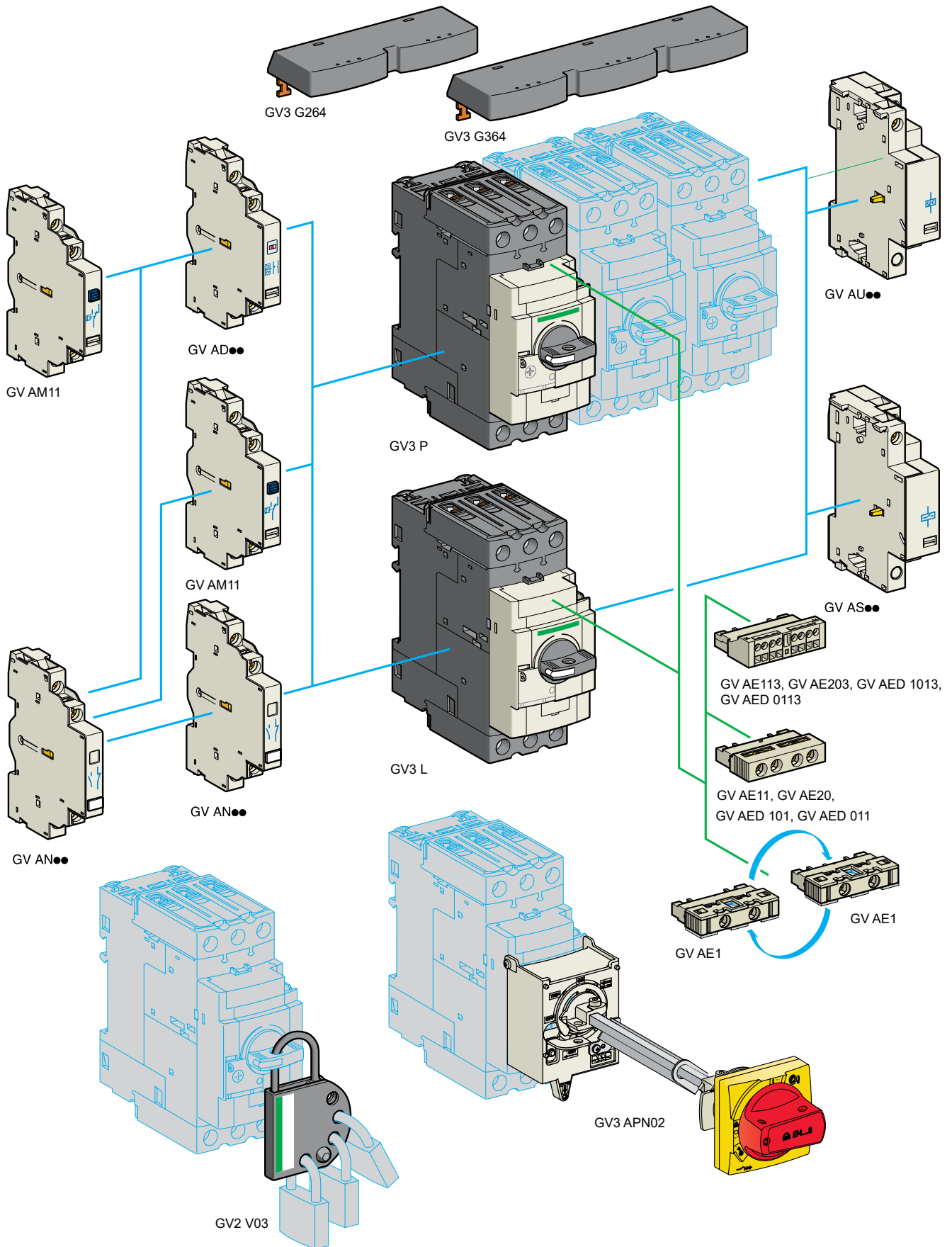

### Vario Switch Disconnectors

[Ithe] Conventional Thermal Current**	Poles Description	Rated Operational Power (AC-23)*	Reference	Unit MRP [₹]
<b>Complete Enclosed Switches</b>				
• Range 12 to 175A, IP 65 Sealable and Lockable				
10	3P	4 kW	VCF02GE	5360
16	3P	5.5 kW	VCF01GE	5825
20	3P	7.5 kW	VCF0GE	7090
25	3P	11 kW	VCF1GE	7600
32	3P	15 kW	VCF2GE	8905
50	3P	22 kW	VCF3GE	13770
63	3P	30 kW	VCF4GE	16110

\* Rated Power at 690V

\*\* Ith in enclosure

For Switch Type (Amps)	Mounting Arrangement	Ingress	Reference	Unit MRP [₹]
<b>Operators (Padlockable)</b>				
12 - 40	4 Screw Fixing	IP65	KCF1PZ	1585
63 - 80	4 Screw Fixing	IP65	KCF2PZ	1675
125 - 175	4 Screw Fixing	IP40	KCF3PZ	6780

### Vario Switch Disconnectors

[Ithe] onventional Thermal Current**	Poles Description	Reference	Unit MRP [₹]
<b>Complete Switch with Padlockable Operator</b>			
• Suitable for Front Mounting or Base Mounting			
12	3P	VCF02	3365
20	3P	VCF01	3660
25	3P	VCF0	4270
32	3P	VCF1	4470
40	3P	VCF2	5545
63	3P	VCF3	11615
80	3P	VCF4	9400
125	3P	VCF5	21545
175	3P	VCF6	26115
<b>Switch Bodies</b>			
12		V02	2190
20		V01	2530
25		V0	3005
32		V1	3660
40		V2	4470
63		V3	6230
80		V4	8190
125		V5	16615
175		V6	21215

### Accessories

Description	For Use with Switch Bodies	Rating in A	Pole Composition	Earth Contact	Auxiliary Contacts	Reference	Unit MRP [₹]
<b>Vario Add-on Modules <sup>(1)</sup></b>							
Main Pole Module	V02/VCF02	12	1P	-	-	VZ02	1570
	V01/VCF01	20	1P	-	-	VZ01	1595
	V0/VCF0	25	1P	-	-	VZ0	1705
	V1/VCF1	32	1P	-	-	VZ1	1660
	V2/VCF2	40	1P	-	-	VZ2	1780
	V3/VCF3	63	1P	-	-	VZ3	2315
	V4/VCF4	80	1P	-	-	VZ4	2315
Neutral Pole Module <sup>(2)</sup>	V02 / VCF02 to V2 / VCF2	-	1N	-	-	VZ11	1915
	V3 / VCF3 to V4 / VCF4	-	1N	-	-	VZ12	2560
	V5 / VCZ5 to V6 / VCZ6	-	1N	-	-	VZ13	5285
Earthing Module	V02 / VCF02 to V2 / VCF20	-	-	-	-	VZ14	1880
	V3 / VCF3 to V4 / VCF4	-	-	1	-	VZ15	2220
	V5 / VCZ5 to V6 / VCZ6	-	-	1	-	VZ16	3450
Auxiliary Contact Block Module	V02/ VCF02 to V6 / VCZ6	-	-	-	1NO + 1NC	VZ7	1965
	V2/ VCF02 to V6 / VCZ6	-	-	-	2NO	VZ20	1965

(1) For mounting option of modules, please refer to the technical catalogue.

(2) With early make and late break contacts

Description	For Use With	Reference	Unit MRP [₹]
<b>Components for Door Interlocking</b>			
Shaft extension - for Mini-VARIO and VARIO - V02..V2	V02...V2	VZ17	1880
	V02...V2	VZ30	2220
Shaft extension - for Mini-VARIO and VARIO - V3 V4 V5 V6	V3, V4, V5, V6	VZ18	2220
	V3, V4, V5, V6	VZ31	2530
Door interlock plate	VZ17 / VZ30	KZ32	675
	VZ18/31	KZ74	1155
<b>Input Terminal Protection Shrouds</b>			
Terminal Shrouds	V02 - V2	VZ8	640
	V3 - V4	VZ26	555
	V3 - V4	VZ9	665
	V5 - V6	VZ27	555
	V5 - V6	VZ10	840
	V02 - V6	VZ28	940
	V02 - V6	VZ29	770

For details on non standard references, technical parameters, accessories, compatibility, stockable and non stockable status please contact Customer Care

NORMAL STOCK ITEMS

W.E.F. January 15<sup>th</sup>, 2026

# TeSys Control

## Accessories for Switches

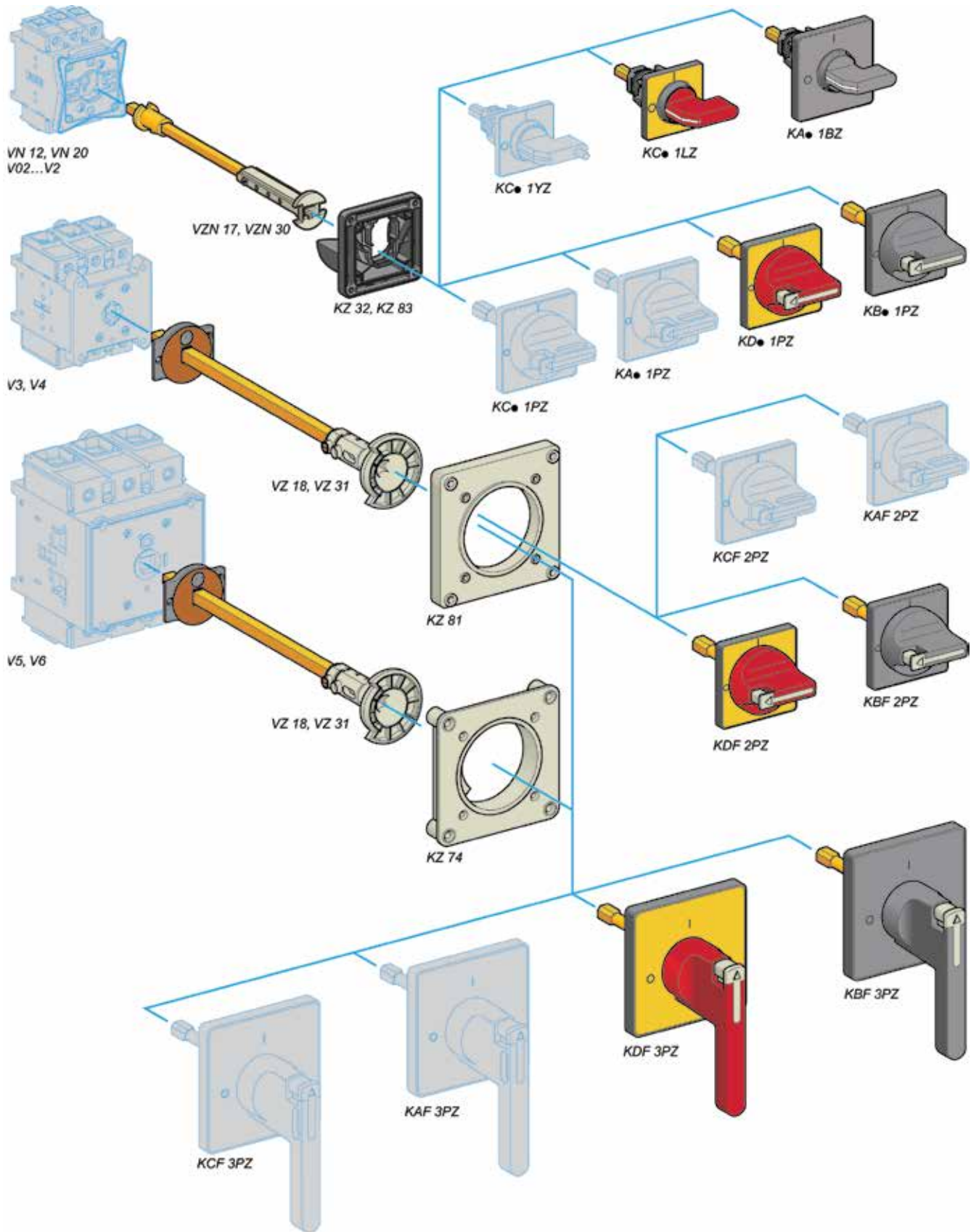



# Smarter Load Management with TeSys Island

The Key to Unprecedented Efficiency

## Digital Load Manager

TeSys Island - the innovative & digital multifunctional load management solution up to 80A

Industry 4.0

Predictive Maintenance

Cyber Secure



# TeSys Active

## TeSys Island

### • All-in-one Solution for Versatile & Flexible Load Management •

#### Motor Protection

- Motor Overload
- Over/Under Current
- Jam/Stall
- Long Start
- Rapid Restart Lockout

#### Upstream Protection

- Phase Loss
- Phase Reversal
- Phase Unbalance
- Ground Current Detection

#### Analytics

- Health Diagnostic
- Energy Management
- Demand Management

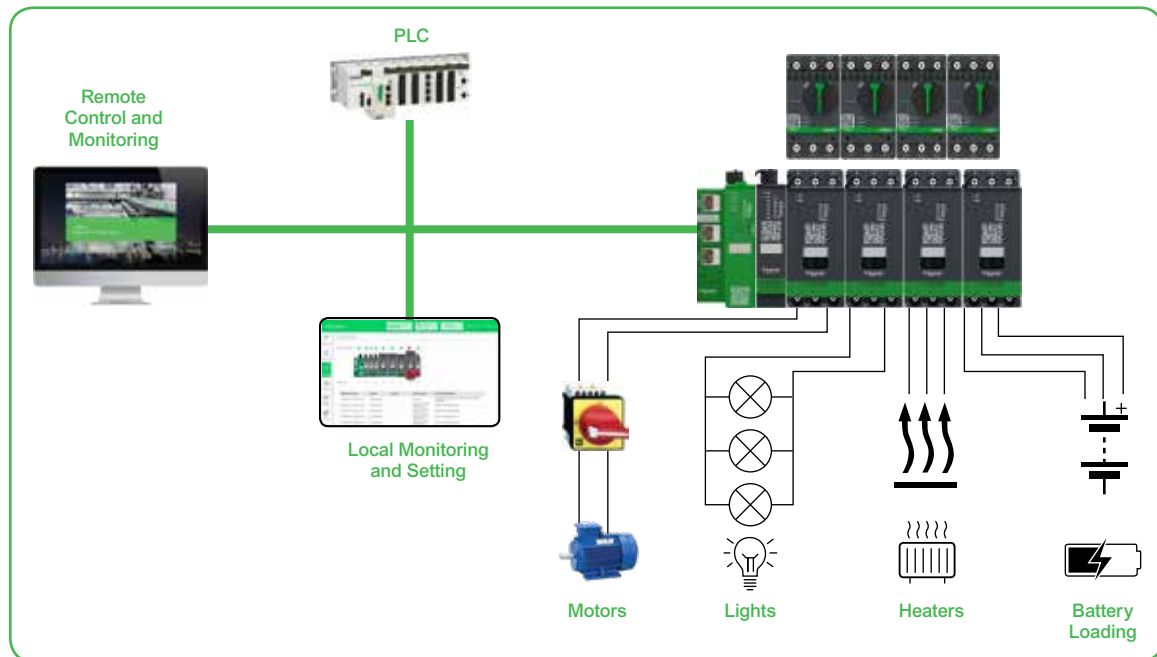

Designation	Product Specification	Commercial Reference
<b>TeSys island components</b>		
Standard Starter	9A (AC-3)	TPRST009
Standard Starter	25A (AC-3)	TPRST025
Standard Starter	38A (AC-3)	TPRST038
Standard Starter	65A (AC-3)	TPRST065
Standard Starter	66A (AC-3) - 80A (AC-1)	TPRST080
SIL Starter	9A (AC-3)	TPRSS009
SIL Starter	25A (AC-3)	TPRSS025
SIL Starter	38A (AC-3)	TPRSS038
SIL Starter	65A (AC-3)	TPRSS065
SIL Starter	66A (AC-3) - 80A (AC-1)	TPRSS080
Power interface module	9A (AC-3)	TPRPM009
Power interface module	38A (AC-3)	TPRPM038
Power interface module	80A (AC-3)	TPRPM080
Voltage interface module		TPRVM001
SIL interface module		TPRSM001
Digital I/O module	(4 input - 2 output)	TPRDG4X2
Analog I/O module	(2 input -1 output)	TPRAN2X1
Bus Coupler	EtherNet/IP - Modbus TCP	TPRBCEIP
Bus Coupler	PROFINET	TPRBCPFN
Bus Coupler	PROFIBUS	TPRBCPF8
<b>Assembly and Wiring Kits</b>		
Kit for reversing starter application	for 9, 25, 38A (size 1 and 2) starters	LAD9R1
Kit for reversing starter application	for 65, 80A (size 3) starters	LAD9R3
Jumper bar 3-pole for Star Delta application	for 9, 25, 38A (size 1 and 2) starters	LAD9P3
Kit for reversing starter application	for 65, 80 A (size 3) starters, a hazard sticker is provided	LAD9SD3S

\*Architecture shown above is only for graphical representation

# TeSys Control

## Ultra motor starters

### Introduction

From traditional solution



Ultra motor starter- All in one block for advance protection

Motor circuit breaker:  
GV2L



Magnetic protection  
> short-circuit protection

Contactor:  
LC1D



Control  
> Start/Stop

Status monitoring  
> signaling  
> alarm monitoring

Protection relay:  
LRD



Thermal protection  
> overload



Ultra motor starter  
> All basic or advanced protection and control functions in one block

and more...

- > Overload indication and alarm
- > Status report, remote control via communication bus

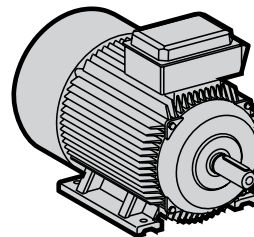

**Ultra motor starters**  
can be used in  
**80 %**  
of motor protection and control applications.

# TeSys Control

## Ultra motor starters



- Total Coordinated Starter – 3 functions in a single device
- Compact Starter, DOL / RDOL upto 18.5kW (38A, AC-3) in 45mm width
- Direct connectivity to Modbus / Profibus / CANopen / DeviceNet
- Higher switching life - 15Million operations, 2Million AC-43 electrical life
- Breaking capacity upto 130kA

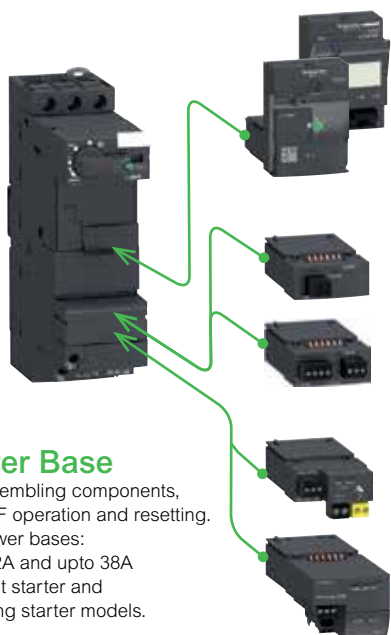

### Control Unit

Performs all the electrical protection functions to cover main applications from 0 to 38A.

Some of these also provide advanced measurement, alarm and display functions.

### 4 simple function modules

Thermal overload alarm Indication of motor load  
Thermal overload signalling and manual reset  
Thermal overloaded signalling and automatic or remote reset.

### 4 communication modules

Profibus DP  
CANopen  
DeviceNet  
Modbus.

### Power Base

For assembling components, ON/OFF operation and resetting.  
> 3 power bases:  
upto 12A and upto 38A  
> Direct starter and reversing starter models.

## 40%

“TeSys solutions allow us to reduce the size of our enclosure” says a panel builder from the water treatment sector

## 60%

“Late customization means that we can build 60% of the panels, even though the project design has not yet been completed” says an engineer in a food processing industry

## Quick Selection

Select 1	+	Select 1	Optional	or	Optional	or	Optional											
<b>Base Power Unit</b> Non-Reversing LUB 120 0.. 12A with terminal 12 0.. 12A no terminal 120* 0.. 32A with terminal 32 0.. 32A no terminal 320* 0.. 38A with terminal 38 0.. 38A no terminal 380* Reversing LU2B 120 BL 0.. 12A with terminal 12 0.. 12A no terminal 120* 0.. 32A with terminal 32 0.. 32A no terminal 320* 0.. 38A with terminal 38 0.. 38A no terminal 380* 24 V DC BL 24 V AC B 48...72 VAC or 48 VDC ES 110..240 VAC/DC FU <small>*prewired cables to be ordered separately</small>		<b>Control Unit</b> LUC B X6 BL Class 10, 3Ph B Class 10, 1Ph C Class 20, 3Ph D 0.15 to 0.6 A X6 0.35 to 1.4 A 1X 1.25 to 5 A 05 3 to 12 A 12 4.5 to 18 A 18 8 to 38 A 38 24V DC BL 24VAC B 48...72 VAC/48 VDC ES 110..240VAC/DC FU	<b>Communication Module*</b> LU9C 033 Modbus Serial 033 Profibus DP 07 CANopen 08 DeviceNet 09 <b>Prewired Cables</b> <table border="1"> <thead> <tr> <th>Description</th> <th>Reference</th> </tr> </thead> <tbody> <tr> <td>Prewired cable for non-reversing power base</td> <td>LU9BN11C or LU9BN11L</td> </tr> <tr> <td>Prewired cable for reversing power base</td> <td>LU9MRC or LU9MRL</td> </tr> </tbody> </table>	Description	Reference	Prewired cable for non-reversing power base	LU9BN11C or LU9BN11L	Prewired cable for reversing power base	LU9MRC or LU9MRL	<b>Function Module</b> LU9F DH11 Fault diff. with manual reset DH11 Fault diff. with auto reset DA10 Thermal overload pre-alarm W10 Motor load indication (4-20mA) V2	<b>Auxiliary Contacts</b> Contactor auxiliary contacts LU9N 11 1NO + 1NC 11 2NC 02 2NO 20 Side contacts 2NO LU9AE20 Power auxiliary contacts (trip status) LU9A1C 20 1NO + 1NC 11 2NO 20	<b>Accessories</b> <table border="1"> <thead> <tr> <th>Description</th> <th>Reference</th> </tr> </thead> <tbody> <tr> <td>Line spacer for UL508 Type E</td> <td>LU9SPO</td> </tr> <tr> <td>Current limiter 130kA@460V</td> <td>LUALB1</td> </tr> </tbody> </table>	Description	Reference	Line spacer for UL508 Type E	LU9SPO	Current limiter 130kA@460V	LUALB1
Description	Reference																	
Prewired cable for non-reversing power base	LU9BN11C or LU9BN11L																	
Prewired cable for reversing power base	LU9MRC or LU9MRL																	
Description	Reference																	
Line spacer for UL508 Type E	LU9SPO																	
Current limiter 130kA@460V	LUALB1																	

\*Suitable with 24V DC starter variant only

**Note:** For prices please contact Customer Care



## Wherever productivity is a concern, intelligence to Motor Control is the solution

### Transform Your Conventional MCC into a Smart Powerhouse!

Upgrade to the Intelligent Motor Control Center (iMCC) with TeSys Tera – an advanced intelligent relay that brings next-level protection, real-time insights, and built-in smart features.



# TeSys Tera NEW

Experience the enhanced intelligence of your Motor Management System with our new and advanced TeSys Tera.



- Sustainable
- Versatile
- Efficient
- Modular

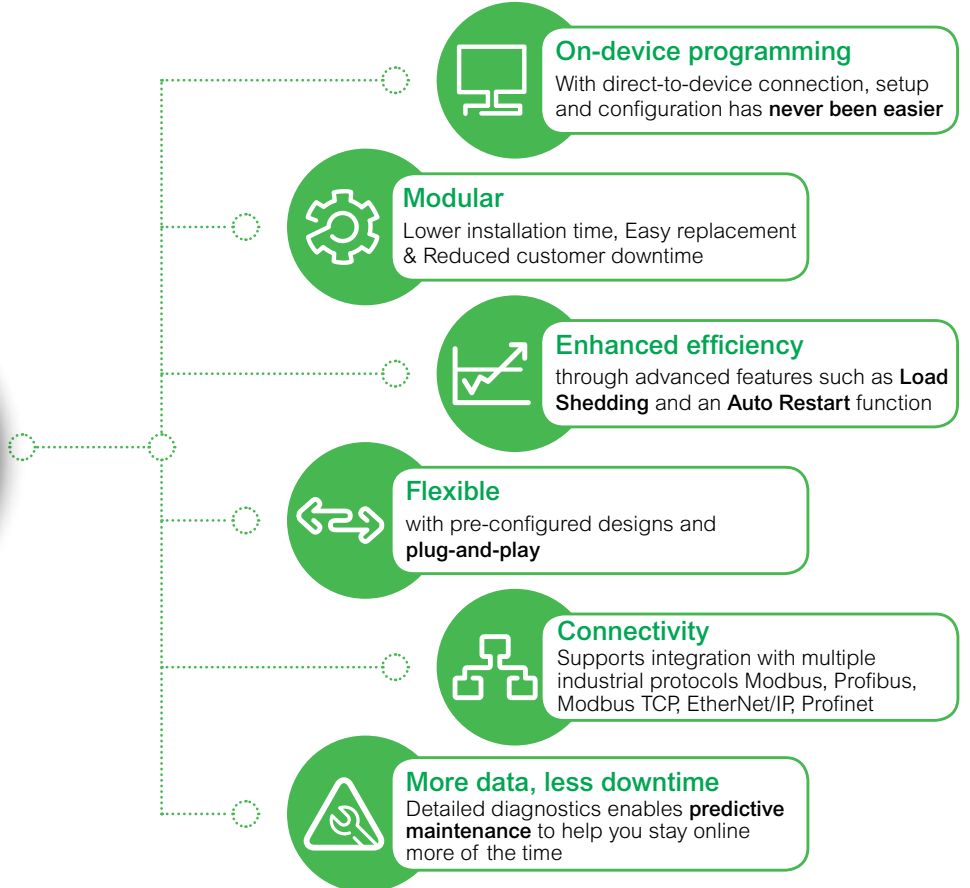

# TeSys Active

## Tera Motor Management System

### Main Unit

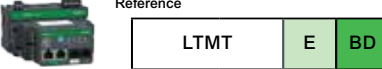

Reference: **LTMT E BD**

Network Protocol	Ethernet IP / Modbus TCP/IP	E	BD
	Modbus	M	
	Profibus DP	P	
	ProfiNet	PN	

Control Voltage	24 V DC	BD
	110-240V AC/DC	FM

### Sensor Module

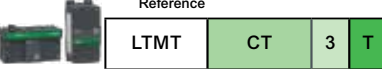

Reference: **LTMT CT 3 T**

Current Range	0.3-3 A	3
	2.5-25 A	25
Current Range	7-70 A*	70
	10-100 A**	100

Mounting	Horizontal	T
	Vertical	L

Only current measurement CT  
 Current and voltage measurement CTV (60...690 V AC)

### Expansion Module



Reference: **LTMT IN42 BD**

Expansion Type	4DI+2DO	IN42	BD
	6DI	IN60	
	2AI+1AO	AN21	
	EF+2DI+2DO	ZCT22*	
Control Voltage	24 V DC	BD	
	110-240V AC	FM	

Temperature PTC

\*Not applicable for Horizontal CT  
 \*\* Not applicable for Vertical CT

\*Only applicable with Vertical CT's

### TeSys Tera Accessories

#### Control Operator Unit

Description	Reference
Powered from LTMT Main Unit	LTMTCUF
Displays parameters, alarms and trip & controls the motor	
Provides the FDR (Fast Device Replacement) service with configuration backup	



#### Current Transformers

Primary [A]	Secondary [A]	Reference
100	1	LT6 CT1001
200	1	LT6 CT2001
400	1	LT6 CT4001
800	1	LT6 CT8001



#### Ground Fault CT's

Primary [A]	Internal Ø "d" [mm]	Reference
65	30	50437
85	50	50438
160	80	50439
250	120	50440
400	200	50441
630	300	50442



#### Connecting Cables

Description	Number and type of connectors	Length m	Reference
For connecting the Main Controller to the Sensor Module	2 x RJ11	0.15	LTMT9RJ1015
		0.2	LTMT9RJ102
		0.5	LTMT9RJ105
For connecting the Main Controller to the LTMTCUF Control Operator Unit	2 x RJ45	1	LTMT9CU10S
For connecting the Main Controller to the Expansion Module	2 x RJ45	3	LTMT9CU30S
		0.1	LTMT9RJ401
		1	LTMT9EX10



Description	Composition	Reference
Programming software SoMove	1 Program for each PC	On request
Connection cable for PC	USB to RJ45 cable	TCSMCNAM3M002P











## Schneider Electric India Pvt. Ltd.

Corporate Office: 15th Floor, DT-4 Downtown, DLF Phase 3, Sector 25A, Gurugram, Haryana - 122002

### Ahmedabad

Schneider Electric India (P) Ltd.  
1506-1507, 15<sup>th</sup> Floor Shaph-5  
Opp.Karnavati Club, SG Highway,  
Ahmedabad, Gujarat - 380015  
Tel.: 079-66826701

### Coimbatore

Schneider Electric India Pvt. Ltd.  
Mikro Grafeo Services Pvt Ltd.,  
Elysium Tower, #21, A.T.T  
Colony, Near Honda Office,  
Coimbatore, Tamil Nadu - 641018

### Lucknow

Schneider Electric India (P) Ltd.  
Summit, Plot No. TCG 3/3  
6<sup>th</sup> Floor, 604A/B/C, Vibhuti Khand  
Gomti Nagar, Lucknow  
Uttar Pradesh - 226010  
Tel.: 0522-3500334

### Nashik

Schneider Electric India (P) Ltd.  
401, 4<sup>th</sup> Floor, Rishi Raj Towers  
Jehan Circle, Gangapur Road  
Nashik - 422013  
Tel.: 0253-2344333

### Bengaluru

Schneider Electric India (P) Ltd.  
No. 3/1, JP Techno Park  
Mezzanine Floor, Millers Tank Bund  
Road, Vasanth Nagar  
Bengaluru - 560052  
Tel.: 080-71481351

### Hyderabad

Schneider Electric Pvt. Ltd.  
4B-4th Floor, Gumidelli Towers,  
Prakash Nagar, Begumpet,  
Hyderabad - 500016

### Ludhiana

Schneider Electric India (P) Ltd.  
SCO 23, 2nd Floor,  
Chandigarh Road, Sector 32  
Ludhiana, Punjab -141010  
Tel.: 0161- 5203011

### New Delhi

Schneider Electric India (P) Ltd.  
C-56, Mayapuri Industrial Area, Phase-2  
New Delhi - 110064  
Tel.: 011-61317400

### Bhubaneswar

Schneider Electric India (P) Ltd.  
Workloop Co-Working in the property  
Office No. 316, Esplanade One Mall  
Rasulgarh, Bhubaneswar - 751010

### Indore

Schneider Electric India (P) Ltd.  
219, Dhan Trident Building  
Vijay Nagar, A.B.Road  
Indore - 452001

### Mohali

Schneider Electric India (P) Ltd.  
2nd Floor, Tower-A  
Bestech Business Tower  
Mega Information & Technology Park  
Industrial Plot No.1, Phase IX  
(Expansion), Mohali - 160059  
Tel.: 0172-7198200

### Pune

Schneider Electric India (P) Ltd.  
Amar Caliber, CTS No 911, BMCC Road,  
OFF F.C. Road, Deccan Gymkhana,  
Shivaji Nagar, Pune - 411007  
Tel.: 020-67492500

### Chennai

Schneider Electric India (P) Ltd.  
No: 29, 2<sup>nd</sup> Floor,  
Bannari Amman Towers, B-Block  
Dr. Radhakrishnan Road, Mylapore  
Chennai - 600 004  
Tel.:044-71912000

### Jaipur

Schneider Electric India (P) Ltd.  
Jaipur Business Centre 309  
3<sup>rd</sup> Floor, Sangam Tower 190  
Church Road, Jaipur - 302001  
Tel.: 0141-2374810

### Mumbai

Schneider Electric India Pvt. Ltd.  
L&T Business Park, Tower B,  
7th Floor, TC-II, Gate No.5,  
Saki Vihar Road, Powai,  
Mumbai - 400072

### Vadodara

Schneider Electric India (P) Ltd.  
Notus IT Park, 10<sup>th</sup> Floor, Block-D  
Sarabhai Campus, Vadiwadi  
Vadodara, Gujarat - 390017

### Cochin

Schneider Electric India (P) Ltd.  
Alapatt Properties Private Limited  
(Trade Name: Centre A)  
Main Door Number: 66/4971  
(Old Door Number: 40/6584-H)  
7<sup>th</sup> Floor Alapatt Heritage Building  
MG Road Kochi - 682035

### Kolkata

Schneider Electric (I) Pvt. Ltd.  
BN3, Salt Lake, Sector V,  
Kolkata - 700091

### Nagpur

Schneider Electric India (P) Ltd.  
6, Vasant Vihar Complex  
W.H.C Road, Shankar Nagar  
Nagpur - 440010  
Tel.: 0712-2558581

### Vishakhapatnam

Schneider Electric India (P) Ltd.  
D.N.10-1-43, 1<sup>st</sup> Floor  
Ratnam's Business Centre,  
Siripuram Fort, C.B.M.Compound  
Visakhapatnam - 530016  
Tel.: 0891-6675500

### Customer Care Centre

Monday-Saturday, 9 a.m. to 8 p.m.  
Toll-free numbers: 1800 419 4272, 1800 103 0011  
Email: [customer-care.in@schneider-electric.com](mailto:customer-care.in@schneider-electric.com)

For more information, visit our website at: [www.se.com/in](http://www.se.com/in)

- All Prices are in Indian Rupees
- Prices are subject to change without prior notice
- Product evolution is a continuous process and Schneider Electric reserves the right to modify/withdraw any product at any time without prior notice
- Prices charged will be as prevailing on the date of dispatch
- Invoice Amount = (MRP – less Applicable discount) + Applicable GST %
- Tax incidence on invoices is basis applicable GST rates
- Invoice amount not to exceed MRP
- Product pictures shown are for illustration purpose only; actual product may vary
- Kindly refer product datasheet for detailed specification

Distributor